



CHB350 Series Application Note V17

ISOLATED DC-DC CONVERTER CHB350 SERIES APPLICATION NOTE



Approved By:

Department	Approved By	Checked By	Written By
Research and Development Department	Jacky	Danny/Eunice	Joyce
Design Quality Department	Benny	JoJo	



CHB350 Series Application Note V17

Contents

1. Introduction	3
2. DC-DC Converter Features.....	3
3. Electrical Block Diagram	3
4. Technical Specifications.....	4
5. Main Features and Functions.....	8
5.1 Operating Temperature Range.....	8
5.2 Output Voltage Adjustment.....	8
5.3 Over Current Protection.....	8
5.4 Output Over Voltage Protection.....	8
5.5 Remote On/Off.....	8
5.6 UVLO (Under Voltage Lock Out)	8
5.7 Over Temperature Protection	8
6. Applications.....	9
6.1 Recommended Layout, PCB Footprint and Soldering Information.....	9
6.2 Convection Requirements for Cooling	9
6.3 Thermal Considerations	9
6.4 Power De-rating	10
6.5 Half Brick Heat Sinks:.....	11
6.6 Efficiency VS. Load	12
6.7 Test Set-Up.....	14
6.8 Output Voltage Adjustment.....	14
6.9 Output Remote Sensing	17
6.10 Output Ripple and Noise	17
6.11 Output Capacitance.....	17
7. Safety & EMC	18
7.1 Input Fusing and Safety Considerations	18
7.2 EMC Considerations.....	18
8. Part Number.....	23



CHB350 Series Application Note V17

1. Introduction

This specification describes the features and functions of Cincon's CHB350 series of isolated DC-DC converters. These are highly efficient, reliable and compact, high power density, single output DC/DC converters. The modules can be used in the field of telecommunications, data communications, wireless communications, servers etc. The CHB350 series can deliver up to 70A output current and provide a precisely regulated output voltage over a wide range of 18-36 and 36-75VDC. The modules can achieve high efficiency up to 92.5%. The module offers direct cooling of dissipative components for excellent thermal performance. Standard features include remote on/off(positive or negative), remote sense, output voltage adjustment, over voltage, over current and over temperature protection.

2. DC-DC Converter Features

- 231 - 350W Isolated Output
- Efficiency (at full load) up to 92.5%
- Regulated Output
- Fixed Switching Frequency
- Input Under Voltage Lockout Protection
- Over Current Protection
- Remote On/Off
- Continuous Short Circuit Protection
- Industry Standard Half-Brick Package
- Fully Isolated to 1500VDC
- Safety Meets UL60950-1 and EN60950-1
- High Power Density 123W/in³

3. Electrical Block Diagram

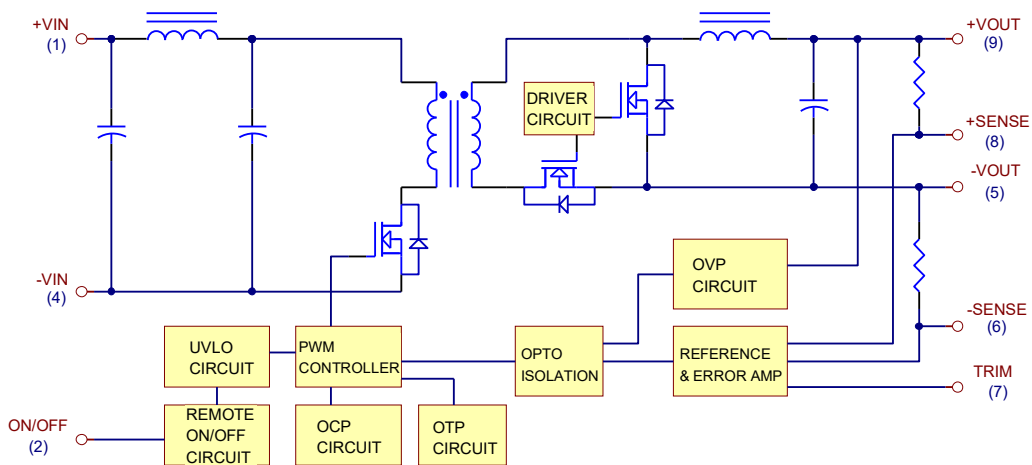

Electrical Block Diagram for 12Vout, 5Vout and 3.3Vout

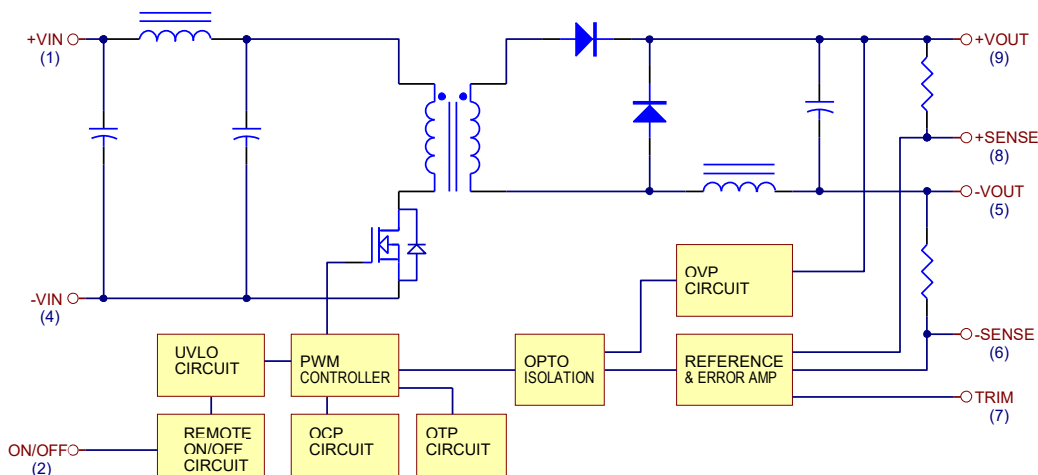

Electrical Block Diagram for other modules



CHB350 Series Application Note V17

4. Technical Specifications

(All specifications are typical at nominal input, full load at 25°C unless otherwise noted.)

ABSOLUTE MAXIMUM RATINGS

Stresses in excess of the absolute maximum ratings can cause permanent damage to the device. These are absolute stress ratings only, functional operation of the device is not implied at these or any other conditions in excess of those given in the operations sections of the data sheet. Exposure to absolute maximum ratings for extended periods can adversely affect the device reliability.

PARAMETER	NOTES and CONDITIONS	Device	Min.	Typical	Max.	Units
Input Voltage						
Continuous		24SXX	-0.3		36	V _{dc}
		48SXX	-0.3		75	
Transient	100ms	24SXX			50	V _{dc}
		48SXX			100	
Operating Case Temperature			-40		100	°C
Storage Temperature			-55		105	°C
Input/Output Isolation Voltage	1 minute		1500			V _{dc}

INPUT CHARACTERISTICS

PARAMETER	NOTES and CONDITIONS	Device	Min.	Typical	Max.	Units
Operating Input Voltage		24SXX	18	24	36	V _{dc}
		48SXX	36	48	75	
Input Under voltage Lockout						
Turn-On Voltage Threshold		24SXX	16	17	18	V _{dc}
		48SXX	34	35	36	
Turn-Off Voltage Threshold		24SXX	15	16	17	V _{dc}
		48SXX	32	33	35	
Lockout Hysteresis Voltage		24SXX		1		V _{dc}
		48SXX		2		
Maximum Input Current	100% Load, V _{in} =18V for 24SXX	24SXX		21.9		A
	100% Load, V _{in} =36V for 48SXX	48SXX		10.8		
No-Load Input Current		24S3V3		140		mA
		24S05		260		
		24S12		250		
		24S24		60		
		24S28		60		
		24S48		60		
		48S3V3		90		
		48S05		130		
		48S12		100		
		48S24		60		
		48S28		60		
48S48		60				
Inrush Current (I ² t)		All			1	A ² s
Recommended Input Fuse	Fast blow type	48SXX		20		A
		24SXX		40		
Input Capacitance (External)	<0.7Ω ESR	48SXX	220			uF
		24SXX	440			



CHB350 Series Application Note V17

OUTPUT CHARACTERISTICS

PARAMETER	NOTES and CONDITIONS	Device	Min.	Typical	Max.	Units
Output Voltage Set Point	V_{in} =Nominal V_{in} , $I_o = I_{o_max}$, $T_c=25^\circ\text{C}$	$V_o=3.3\text{V}$	3.25	3.3	3.35	V_{dc}
		$V_o=5.0\text{V}$	4.925	5	5.075	
		$V_o=12\text{V}$	11.82	12	12.18	
		$V_o=24\text{V}$	23.64	24	24.36	
		$V_o=28\text{V}$	27.58	28	28.42	
		$V_o=48\text{V}$	47.28	48	48.72	
Output Voltage Regulation						
Load Regulation	$I_o=I_{o_min.}$ to $I_{o_max.}$	All			± 0.2	%
Line Regulation	V_{in} =low line to high line	All			± 0.2	%
Temperature Coefficient	$T_c=-40^\circ\text{C}$ to 100°C	All			± 0.03	%/ $^\circ\text{C}$
Output Voltage Ripple and Noise						
Peak-to-Peak	5Hz to 20MHz bandwidth, Full load, 10uF tantalum and 1.0uF ceramic capacitors	$V_o=3.3\&5.0\text{V}$			100	mV
		$V_o=12\text{V}$			120	
		$V_o=24\&28\text{V}$			280	
		$V_o=48\text{V}$			480	
RMS		$V_o=3.3\&5.0\text{V}$			40	
		$V_o=12\text{V}$			60	
		$V_o=24\&28\text{V}$			100	
		$V_o=48\text{V}$			150	
Operating Output Current Range		$V_o=3.3\text{V}$	0		70	A
		$V_o=5.0\text{V}$	0		70	
		$V_o=12\text{V}$	0		29.2	
		$V_o=24\text{V}$	0		14.6	
		$V_o=28\text{V}$	0		12.5	
		$V_o=48\text{V}$	0		7.3	
Output DC Current Limit Inception	Output voltage=90% nominal output voltage	All	105	125	140	%
Maximum Output Capacitance	Full load (resistive)	$V_o=3.3\text{V}$	0		10000	uF
		$V_o=5.0\text{V}$	0		10000	
		$V_o=12\text{V}$	0		10000	
		$V_o=24\text{V}$	0		10000	
		$V_o=28\text{V}$	100		7000	
		$V_o=48\text{V}$	100		2200	

DYNAMIC CHARACTERISTICS

PARAMETER	NOTES and CONDITIONS	Device	Min.	Typical	Max.	Units
Output Voltage Current Transient						
Step Change in Output Current	$dI/dt=0.1\text{A}/\mu\text{s}$, Load change from 75% to 100% to 75% of $I_{o_max.}$	All			± 5	%
Setting Time (within 1% V_{out} nominal)	$dI/dt=0.1\text{A}/\mu\text{s}$	All			500	us
Turn-On Delay and Rise Time						
Turn-On Delay Time, From On/Off Control	$V_{on/off}$ to 90% V_{o_set}	All		35	55	ms
Turn-On Delay Time, From Input	V_{in_min} to 90% V_{o_set}	All		150	165	ms
Output Voltage Rise Time	10% V_{o_set} to 90% V_{o_set}	All		25	35	ms



CHB350 Series Application Note V17

EFFICIENCY

PARAMETER	NOTES and CONDITIONS	Device	Min.	Typical	Max.	Units
100% Load		24S3V3		88		%
		24S05		89		
		24S12		90.5		
		24S24		89		
		24S28		90.5		
		24S48		90		
		48S3V3		89		
		48S05		91		
		48S12		92.5		
		48S24		91.5		
		48S28		92		
		48S48		92		

ISOLATION CHARACTERISTICS

PARAMETER	NOTES and CONDITIONS	Device	Min.	Typical	Max.	Units
Input to Output	1 Minute	All			1500	V _{dc}
Isolation Resistance		All	10			MΩ
Isolation Capacitance		All		2000		pF

FEATURE CHARACTERISTICS

PARAMETER	NOTES and CONDITIONS	Device	Min.	Typical	Max.	Units
Switching Frequency		V _o =3V3&5V		300		KHz
		V _o =12V&24V		330		
		V _o =28V&48V				
On/Off Control, Positive Remote On/Off Logic						
Logic Low (Module Off)		All	0		1.2	V
Logic High (Module On)		All	3.5 or Open Circuit		75	V
On/Off Control, Negative Remote On/Off Logic						
Logic High (Module Off)		All	3.5 or Open Circuit		75	V
Logic High (Module On)		All	0		1.2	V
On/Off Current (for Both Remote On/Off Logic)	I _{on/off} at V _{on/off} =0.0V	All			1	mA
Leakage Current (for Both Remote On/Off Logic)	Logic high, V _{on/off} =15V	All			1	mA
Off Converter Input Current	Shutdown input idle current	All		10	15	mA
Output Voltage Trim Range	V _{in} =high line-low line, P _{out} =max. rated power, I _{out} =max. rated current	Others	-10		+10	%
	V _{in} =18-19V for 24S12, 24S28, 24S48 V _{in} =36-38V for 48S28, 48S48 I _{out} =max. rated current	24S12 V _o =28V 24S48 V _o =48V	-10		0	
	V _{in} =19-36V, P _{out} =max. rated power, I _{out} =max. rated current	24S12 24S28 24S48	-10		+10	
	V _{in} =38-75V, P _{out} =max. rated power, I _{out} =max. rated current	48S28 48S48	-10		+10	
Output Over Voltage Protection		All	115	125	140	%
Over-Temperature Shutdown		All		110		°C



CHB350 Series Application Note V17

GENERAL SPECIFICATIONS

PARAMETER	NOTES and CONDITIONS	Device	Min.	Typical	Max.	Units
MTBF	$I_o=100\%$ of I_{o_max} : $T_a=25^\circ\text{C}$ per MIL-HDBK-217F	All		700		K hours
Weight		All		114		grams



CHB350 Series

Application Note V17

5. Main Features and Functions

5.1 Operating Temperature Range

The CHB350 series converters can be operated within a wide case temperature range of -40°C to 100°C . Consideration must be given to the de-rating curves when ascertaining maximum power that can be drawn from the converter. The maximum power drawn from half brick models is influenced by usual factors, such as:

- Input voltage range
- Output load current
- Forced air or natural convection

5.2 Output Voltage Adjustment

Section 6.8 describes in detail how to trim the output voltage with respect to its set point. The output voltage on 3V3&5V&24V models is adjustable within the range of +10% to -10%. For 12V&28V&48V models, see input& output trim curves.

5.3 Over Current Protection

The converter is protected against over current or short circuit conditions. At the instance of current-limit inception, the module enters a hiccup mode of operation, whereby it shuts down and automatically attempts to restart. While the fault condition exists, the module will remain in this hiccup mode, and can remain in this mode until the fault is cleared. The unit operates normally once the output current is reduced back into its specified range.

5.4 Output Over Voltage Protection

The converter is protected against output over voltage conditions. When the output voltage is higher than the specified range, the module enters a hiccup mode of operation. The operation is identical with over current protection.

5.5 Remote On/Off

The **on/off** input pin permits the user to turn the power module on or off via a system signal. Two remote on/off options are available. Positive logic turns the module on during a logic high voltage on the **on/off** pin, and off during a logic low. Negative logic remote **on/off** turns the module off during a logic high and on during a logic low. The **on/off** pin is internally pulled up through a resistor. A properly de-bounced mechanical switch, open collector transistor, or FET can be used to drive the input of the **on/off** pin.

If not using the remote **on/off** feature:

For positive logic, leave the **on/off** pin open.

For negative logic, short the **on/off** pin to $\text{vin}(-)$.

5.6 UVLO (Under Voltage Lock Out)

Input under voltage lockout is standard with this converter. At input voltages below the input under voltage lockout limit, the module operation is disabled.

5.7 Over Temperature Protection

These modules have an over temperature protection circuit to safeguard against thermal damage. When the case temperature rises above over temperature shutdown threshold, the converter will shut down to protect it from overheating. The module will automatically restart after it cools down.



CHB350 Series Application Note V17

6. Applications

6.1 Recommended Layout, PCB Footprint and Soldering Information

The system designer or end user must ensure that metal and other components in the vicinity of the converter meet the spacing requirements for which the system is approved. Low resistance and inductance PCB layout traces are the norm and should be used where possible. Due consideration must also be given to proper low impedance tracks between power module, input and output grounds. The recommended soldering profile and PCB layout are shown below.

Lead Free Wave Soldering Profile

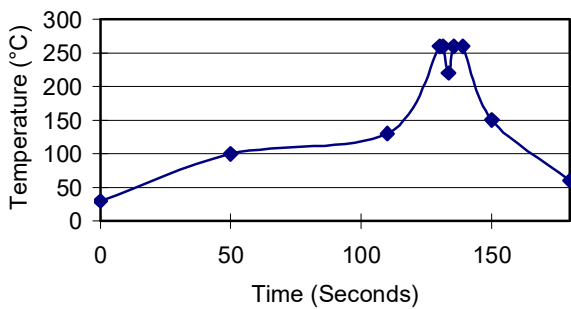

Note :

1. Soldering Materials: Sn/Cu/Ni
2. Ramp up rate during preheat: 1.4°C/Sec (from 50°C to 100°C)
3. Soaking temperature: 0.5°C/Sec (from 100°C to 130°C), 60±20 seconds
4. Peak temperature: 260°C, above 250°C 3~6 Seconds
5. Ramp up rate during cooling: -10.0°C/Sec (from 260°C to 150°C)

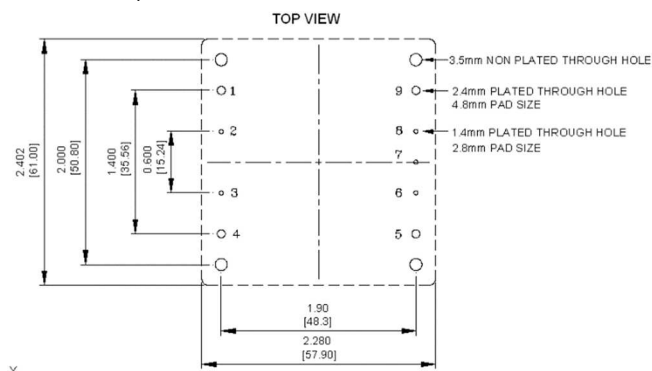

6.2 Convection Requirements for Cooling

To predict the approximate cooling needed for the half brick module, refer to the power de-rating curves in **section 6.4**. These de-rating curves are approximations of the ambient temperatures and airflows required to keep the power module temperature below its maximum rating. Once the module is assembled in the actual system, the module's temperature should be monitored to ensure it does not exceed 100°C as being measured at the center of the top of the case (thus verifying proper cooling).

6.3 Thermal Considerations

The power module operates in a variety of thermal environments; however, sufficient cooling should be provided to help ensure reliable operation of the unit. Heat is removed by conduction, convection, and radiation to the surrounding environment. The test data is presented in **section 6.4**. The power output of the module should not be allowed to exceed rated power ($V_{o_set} \times I_{o_max}$).



CHB350 Series Application Note V17

6.4 Power De-rating

The operating case temperature range of CHB350 series is -40°C to +100°C. When operating the CHB350 series, proper de-rating or cooling is needed. The maximum case temperature under any operating condition should not exceed 100°C.

The following curve is the de-rating curve of CHB350 series without heat sink.

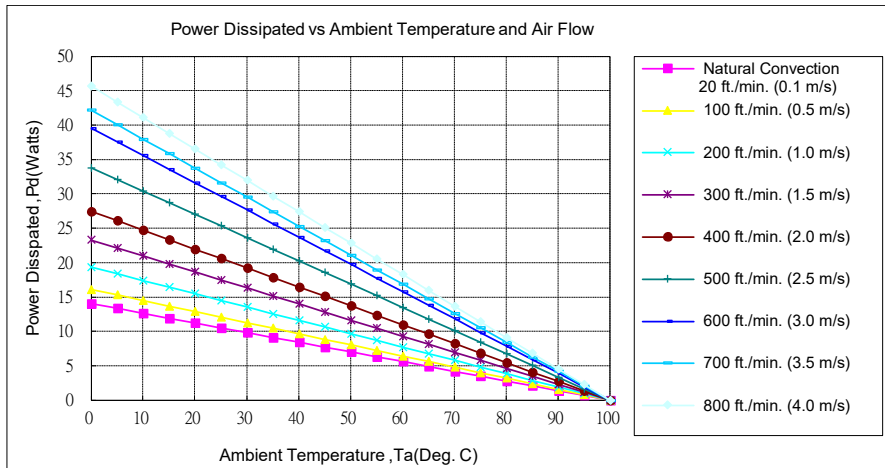

AIR FLOW RATE	TYPICAL R _{ca}
Natural Convection 20ft./min. (0.1m/s)	7.12°C/W
100 ft./min. (0.5m/s)	6.21°C/W
200 ft./min. (1.0m/s)	5.17°C/W
300 ft./min. (1.5m/s)	4.29°C/W
400 ft./min. (2.0m/s)	3.64°C/W
500 ft./min. (2.5m/s)	2.96°C/W
600 ft./min. (2.5m/s)	2.53°C/W
700 ft./min. (2.5m/s)	2.37°C/W
800 ft./min. (2.5m/s)	2.19°C/W

Example (without heat sink):

What is the minimum airflow necessary for a CHB350-48S3V3 operating at nominal line voltage, an output current of 70A, and a maximum ambient temperature of 30°C?

Solution:

Given:

$$V_{in}=48Vdc, V_o=3.3Vdc, I_o=70A$$

Determine power dissipation (P_d):

$$P_d=P_i-P_o=P_o(1-\eta)/\eta$$

$$P_d=3.3V \times 70A \times (1-0.89)/0.89=28.6Watts$$

Determine airflow:

$$\text{Given: } P_d=28.6W \text{ and } T_a=30^\circ C$$

Check power de-rating curve:

$$\text{Minimum airflow}=800 \text{ ft./min.}$$

Verify:

Maximum temperature rise is

$$\Delta T=P_d \times R_{ca}=28.6W \times 2.19=62.6^\circ C$$

Maximum case temperature is

$$T_c=T_a+\Delta T=92.6^\circ C < 100^\circ C$$

Where:

The R_{ca} is thermal resistance from case to ambient environment

T_a is ambient temperature and T_c is case temperature



CHB350 Series Application Note V17

Example (with heat sink M-C308):

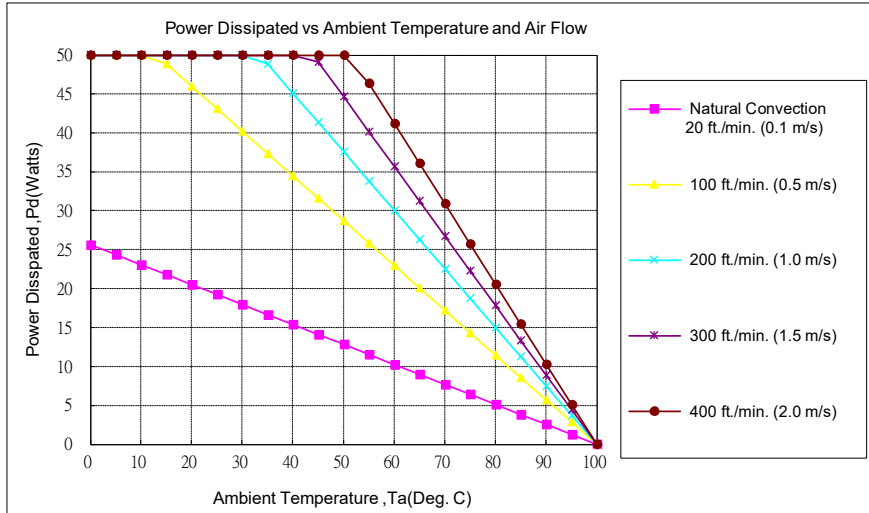

AIR FLOW RATE	TYPICAL R_{ca}
Natural Convection 20ft./min. (0.1m/s)	3.9°C/W
100 ft./min. (0.5m/s)	1.74°C/W
200 ft./min. (1.0m/s)	1.33°C/W
300 ft./min. (1.5m/s)	1.12°C/W
400 ft./min. (2.0m/s)	0.97/W

Solution:

Given:

$$V_{in}=48Vdc, V_o=3.3Vdc, I_o=70A$$

Determine power dissipation (P_d):

$$P_d=P_i-P_o=P_o(1-\eta)/\eta$$

$$P_d=3.3V \times 70A \times (1-0.89)/0.89=28.6Watts$$

Determine airflow:

$$\text{Given: } P_d=28.6W \text{ and } T_a=40^\circ C$$

Check power de-rating curve:

Minimum airflow= 100 ft./min.

Verify:

Maximum temperature rise is

$$\Delta T=P_d \times R_{ca}=28.6W \times 1.74=49.8^\circ C$$

Maximum case temperature is

$$T_c=T_a+\Delta T=89.8^\circ C < 100^\circ C$$

Where:

The R_{ca} is thermal resistance from case to ambient environment

T_a is ambient temperature and T_c is case temperature

6.5 Half Brick Heat Sinks:

Heat sinks assembly [refer to Datasheet-Thermal](#)



CHB350 Series Application Note V17

6.6 Efficiency VS. Load

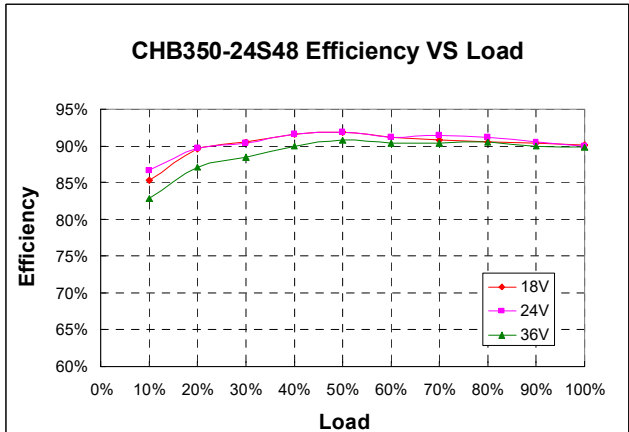
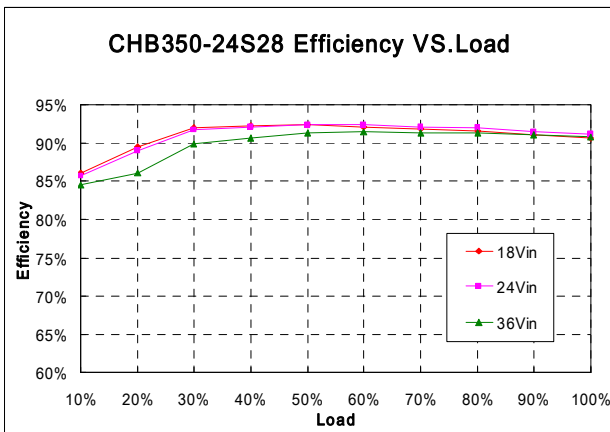
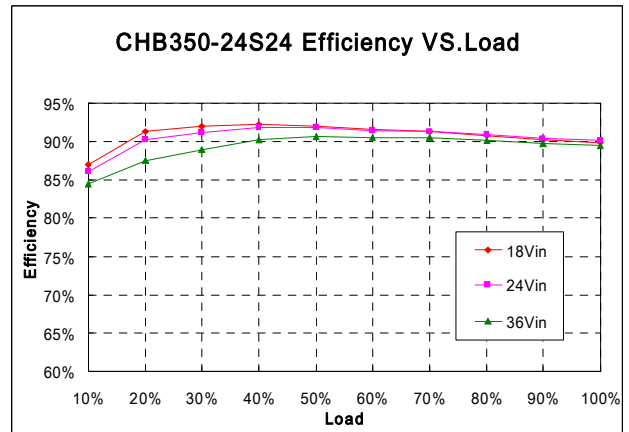
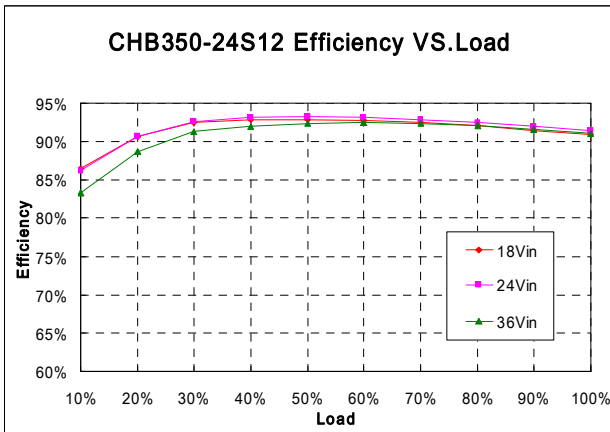
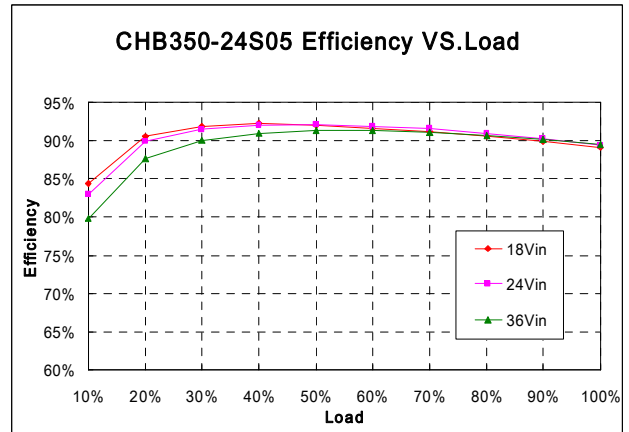
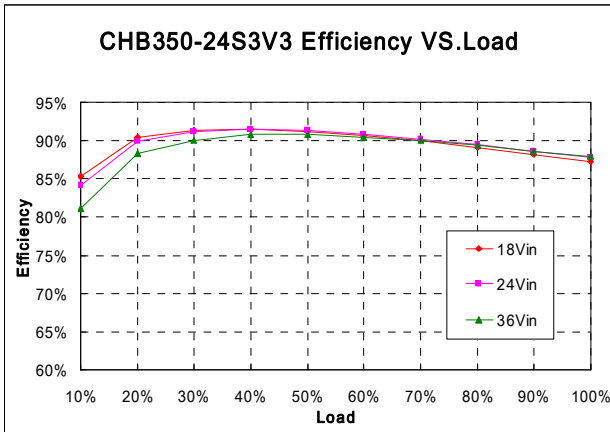



CHB350 Series Application Note V17

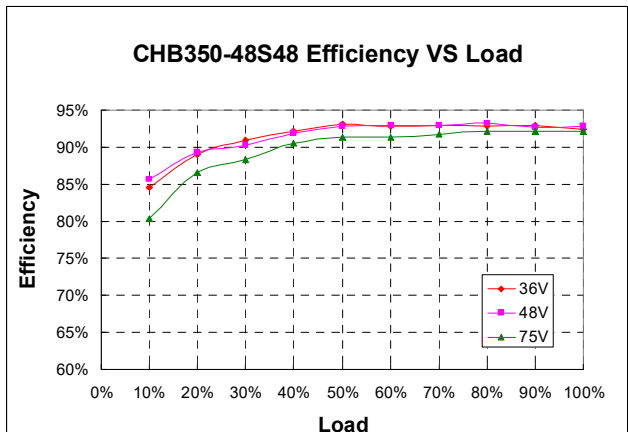
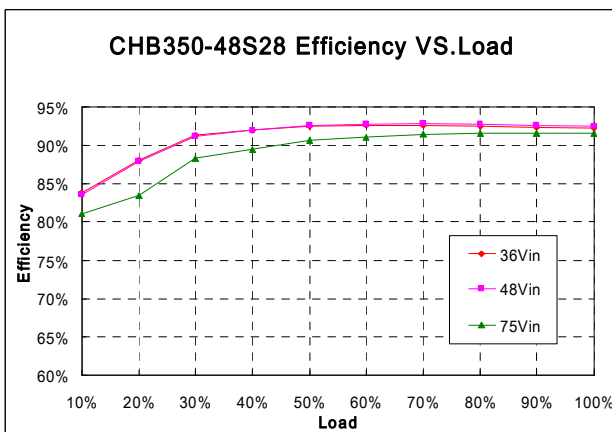
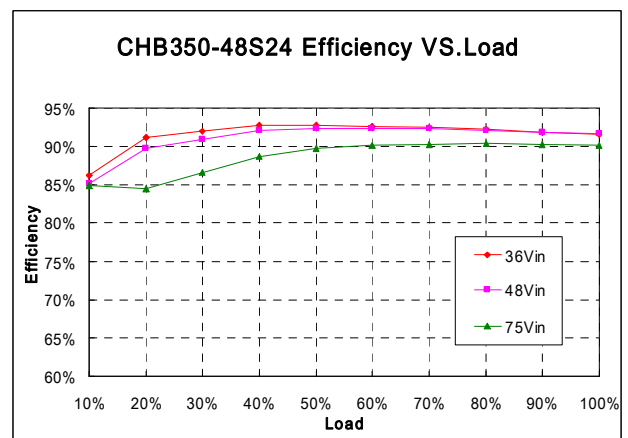
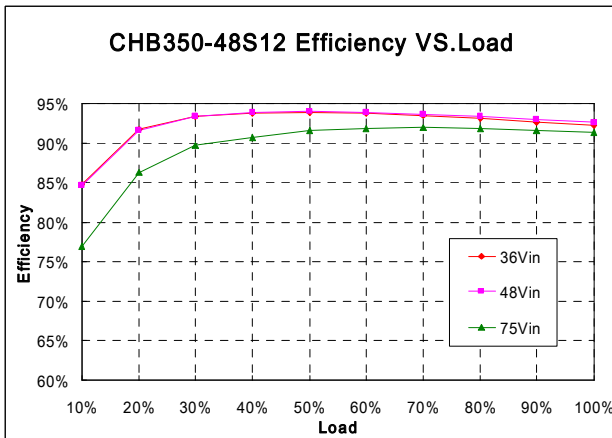
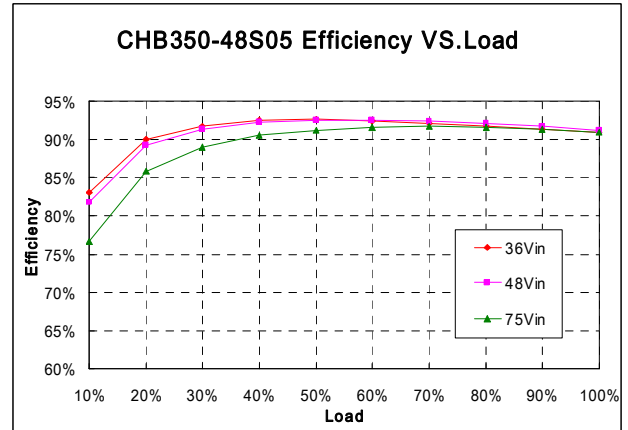
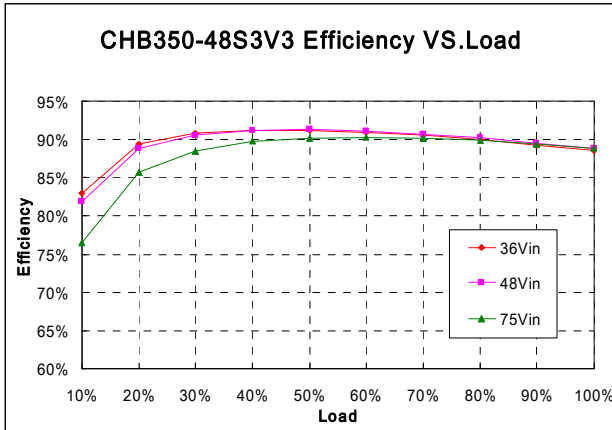



CHB350 Series Application Note V17

6.7 Test Set-Up

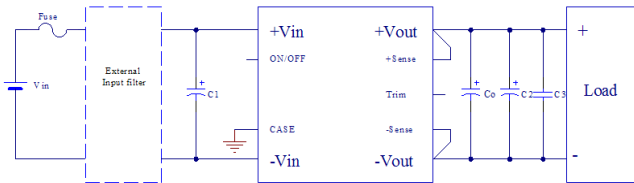

Typical Electrical Connection (Positive Logic)

For typical electrical connection, please refer to the connection above.

1. Put input capacitor, C1, more than 220uF for 48Vin models and more than 440uF for 24Vin models. If the ambient temperature is less than -20°C, use twice of the recommended capacitor above. If the impedance of input line is high, input capacitor must be more than above.
2. Put output capacitor Co according to minimum and maximum capacitor recommendation on **page 5**. If the ambient temperature is less than -20°C, use at least 3 pieces of the recommended minimum capacitors. The C2 and C3 refer to **page 17 item 6.10**.
3. Use external fuse for each unit.

The basic test set-up to measure parameters such as efficiency and load regulation is shown below. When testing the modules under any transient conditions please ensure that the transient response of the source is sufficient to power the equipment under test. We can calculate:

- Efficiency
- Load regulation and line regulation

The value of efficiency is defined as:

$$\eta = \frac{V_o \times I_o}{V_{in} \times I_{in}} \times 100\%$$

Where:

- V_o is output voltage,
- I_o is output current,
- V_{in} is input voltage,
- I_{in} is input current

The value of load regulation is defined as:

$$Load.reg = \frac{V_{FL} - V_{NL}}{V_{NL}} \times 100\%$$

Where:

- V_{FL} is the output voltage at full load
- V_{NL} is the output voltage at no load

The value of line regulation is defined as:

$$Line.reg = \frac{V_{HL} - V_{LL}}{V_{LL}} \times 100\%$$

Where:

- V_{HL} is the output voltage of maximum input voltage at full load
- V_{LL} is the output voltage of minimum input voltage at full load

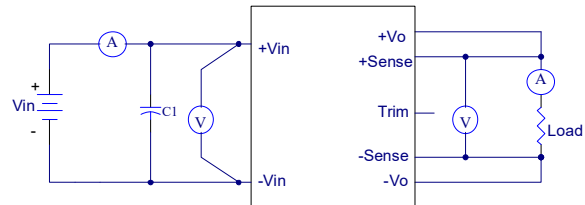

CHB350 Series Test Setup

6.8 Output Voltage Adjustment

The Trim input permits the user to adjust the output voltage up or down 10%. The Trim pin should be left open if trimming is not being used.

Method 1

Connecting an external resistor between the Trim pin and either the $V_{out}(+)$ pin or the $V_{out}(-)$ pin (COM pin), see Figure

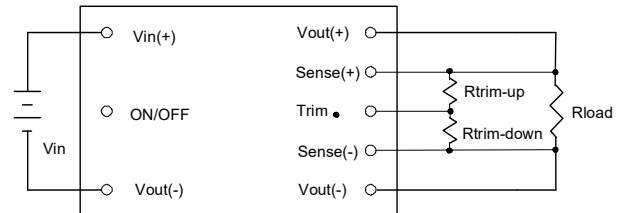

Output Voltage Trim Circuit Configuration

This is accomplished by connecting an external resistor ($R_{trim-down}$) between the Trim pin and the $V_{out}(-)$ (or Sense(-)) pin decreases the output voltage. For 3.3V~28V models, the following equation determines the required external resistor value to obtain a down percentage output voltage change of $\Delta\%$

$$R_{trim-down} = \left[\frac{511}{\Delta\%} - 10.22 \right] k\Omega$$

Where

$$\Delta\% = \left(\frac{V_{o,set} - V_{desired}}{V_{o,set}} \right) \times 100$$

For example, to trim-down the output voltage of 12V module (CHB350-48S12) by 5% to 11.4V, $R_{trim-down}$ is calculated as follow:

$$\Delta\% = 5$$

$$R_{trim-down} = \left(\frac{511}{5} - 10.22 \right) k\Omega$$

$$R_{trim-down} = 91.98 k\Omega$$



CHB350 Series Application Note V17

For 48V models, the following equation determines the required external resistor value to obtain a down percentage output voltage change of $\Delta\%$

$$R_{trim-down} = \left[\frac{2000}{\Delta\%} - 40 \right] k\Omega$$

Where

$$\Delta\% = \left(\frac{V_{o,set} - V_{desired}}{V_{o,set}} \right) \times 100$$

For example, to trim-down the output voltage of 48V module(CHB350-48S48) by 8% to 44.16V, $R_{trim-down}$ is calculated as follow: $\Delta\%=8$

$$R_{trim-down} = \left(\frac{2000}{8} - 40 \right) k\Omega$$

$$R_{trim-down} = 210k\Omega$$

Connecting an external resistor ($R_{trim-up}$) between the Trim pin and the V_{out} (+) (or Sense (+)) pin increases the output voltage. For 3.3V~28V models, the following equations determine the required external resistor value to obtain a up percentage output voltage change of $\Delta\%$.

$$R_{trim-up} = \left[\frac{5.11V_{out}(100 + \Delta\%)}{1.24 \times \Delta\%} - \frac{511}{\Delta\%} - 10.22 \right] k\Omega$$

Where

$$V_{out} = V_{o,set}, \Delta\% = \left(\frac{V_{desired} - V_{o,set}}{V_{o,set}} \right) \times 100$$

For example, to trim-up the output voltage of 12V module (CHB350-48S12) by 5% to 12.6V, $R_{trim-up}$ is calculated as follow:

$\Delta\%=5$

$$R_{trim-up} = \left(\frac{5.11 \times 12 \times (100 + 5)}{1.24 \times 5} - \frac{511}{5} - 10.22 \right) k\Omega$$

$$R_{trim-up} = 926k\Omega$$

For 48V models, the following equations determine the required external resistor value to obtain a up percentage output voltage change of $\Delta\%$.

$$R_{trim-up} = \left[\frac{20V_{out}(100 + \Delta\%)}{1.24 \times \Delta\%} - \frac{2000}{\Delta\%} - 40 \right] k\Omega$$

Where

$$V_{out} = V_{o,set}, \Delta\% = \left(\frac{V_{desired} - V_{o,set}}{V_{o,set}} \right) \times 100$$

For example, to trim-up the output voltage of 48V module(CHB350-48S48) by 8% to 51.84V, $R_{trim-up}$ is calculated as follow: $\Delta\%=8$

$$R_{trim-up} = \left(\frac{20 \times 48 \times (100 + 8)}{1.24 \times 8} - \frac{2000}{8} - 40 \right) k\Omega$$

$$R_{trim-up} = 10161k\Omega$$

The typical value of $R_{trim-down}$

Trim down %	3.3V	5V	12V	15V	24V	28V	48V
	$R_{trim-up}$ (K Ω)						
1%	500.78	500.78	500.78	500.78	500.78	500.78	1960
2%	245.28	245.28	245.28	245.28	245.28	245.28	960
3%	160.11	160.11	160.11	160.11	160.11	160.11	626.67
4%	117.53	117.53	117.53	117.53	117.53	117.53	460
5%	91.98	91.98	91.98	91.98	91.98	91.98	360
6%	74.947	74.947	74.947	74.947	74.947	74.947	293.33
7%	62.78	62.78	62.78	62.78	62.78	62.78	245.71
8%	53.655	53.655	53.655	53.655	53.655	53.655	210
9%	46.558	46.558	46.558	46.558	46.558	46.558	182.22
10%	40.88	40.88	40.88	40.88	40.88	40.88	160

The typical value of $R_{trim-up}$

Trim up %	3.3V	5V	12V	15V	24V	28V	48V
	$R_{trim-up}$ (K Ω)						
1%	852.3	1559.9	4473.4	5722	9468	11132.9	76153.5
2%	427.8	785.1	2256.3	2886.8	4778.3	5619	38443.9
3%	286.4	526.9	1517.3	1941.7	3215.1	3781.1	25874
4%	215.6	397.8	1147.8	1469.2	2433.5	2862.1	19589
5%	173.2	320.3	926.1	1185.7	1964.5	2310.7	15818.1
6%	144.9	268.6	778.3	996.7	1651.9	1943.1	13304.1
7%	124.7	231.7	672.7	861.7	1428.6	1680.6	11508.4
8%	109.5	204.1	593.5	760.4	1261.1	1483.6	10161.6
9%	97.7	182.5	531.9	681.6	1130.8	1330.5	9114.1
10%	88.3	165.3	482.6	618.6	1026.6	1207.9	8276.1



CHB350 Series Application Note V17

Method 2

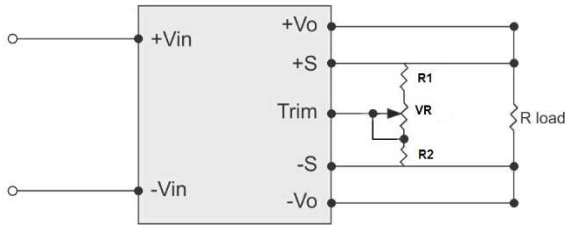

Output Voltage Trim Circuit Configuration with VR

Recommend Resistor Values:

V _{out} (V)	R1 (KΩ)	R2 (KΩ)	VR (KΩ)
3.3	9.1	7.5	10
5	13	5.6	10
12	33	4.7	20
15	36	3.9	20
24	47.5	3	20
28	49.9	2.67	20
48	75	2.2	20

For CHB350-xxS3V3, 05, 12, 24, 28

$$R1 + VR \geq \frac{37.089 \times R2 \times Vo - 40.88 \times R2}{40.88 - R2} (K\Omega) \dots (1)$$

$$R1 \leq \frac{45.331 \times R2 \times Vo - 61.32 \times R2}{61.32 + R2} (K\Omega) \dots (2)$$

$$VR \geq (1) - (2)$$

For CHB350-xxS48

$$R1 + VR \geq \frac{145.161 \times R2 \times Vo - 160 \times R2}{160 - R2} (K\Omega) \dots (1)$$

$$R1 \leq \frac{177.419 \times R2 \times Vo - 240 \times R2}{240 + R2} (K\Omega) \dots (2)$$

$$VR \geq (1) - (2)$$

Ex: CHB350-24S24

IF R2=3KΩ

$$R1 + VR \geq \frac{37.089 \times 3 \times 24 - 40.88 \times 3}{40.88 - 3} = 67.259K\Omega$$

$$R1 \leq \frac{45.331 \times 3 \times 24 - 61.32 \times 3}{61.32 + 3} = 47.884K\Omega$$

$$VR \geq 67.259 - 47.884 = 19.375K\Omega$$

R1 use 47.5K, VR use 20K

Ex: CHB350-24S48

IF R2=2.2KΩ

$$R1 + VR \geq \frac{145.161 \times 2.2 \times 48 - 160 \times 2.2}{160 - 2.2} = 94.911K\Omega$$

$$R1 \leq \frac{177.419 \times 2.2 \times 48 - 240 \times 2.2}{240 + 2.2} = 75.175K\Omega$$

$$VR \geq 94.911 - 75.175 = 19.736K\Omega$$

R1 use 75K, VR use 20K

The output voltage on 3V3&5V&24V models is adjustable within the range of +10% to -10%. For 12V&28V&48V models, see input& output trim curves for trim up and trim down is -10%.

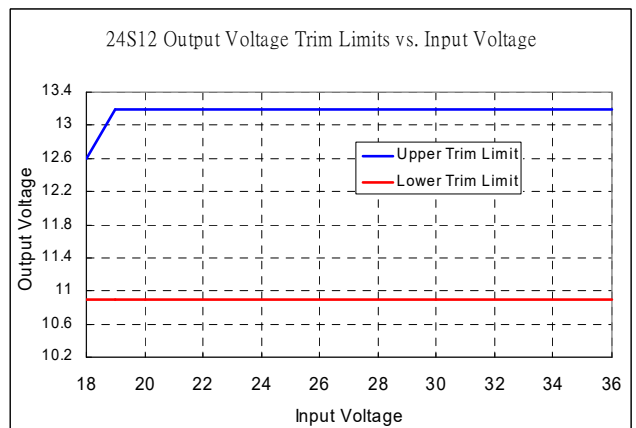
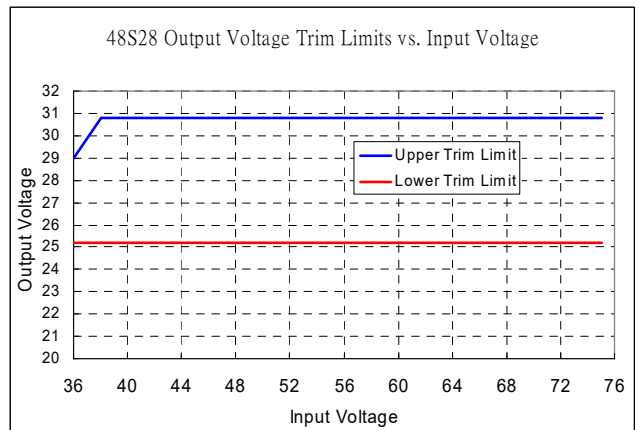
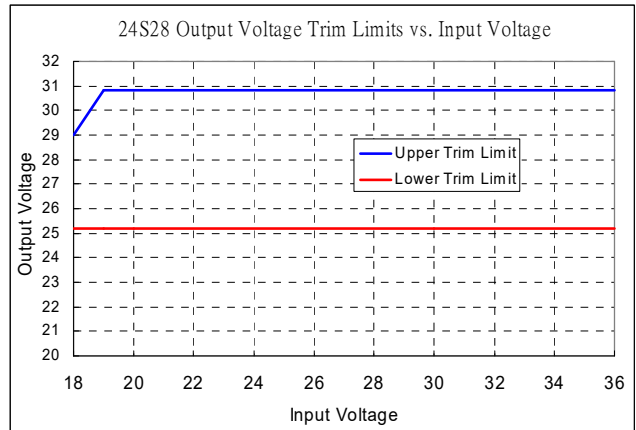



CHB350 Series Application Note V17

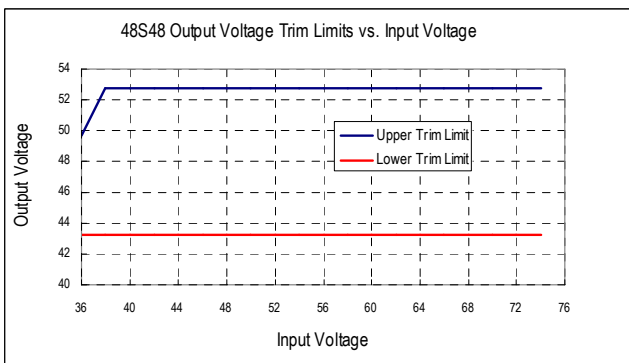
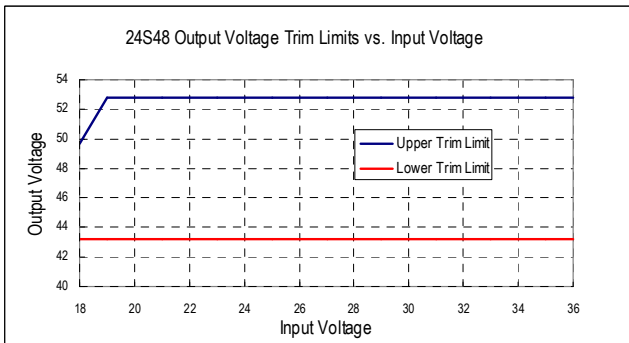
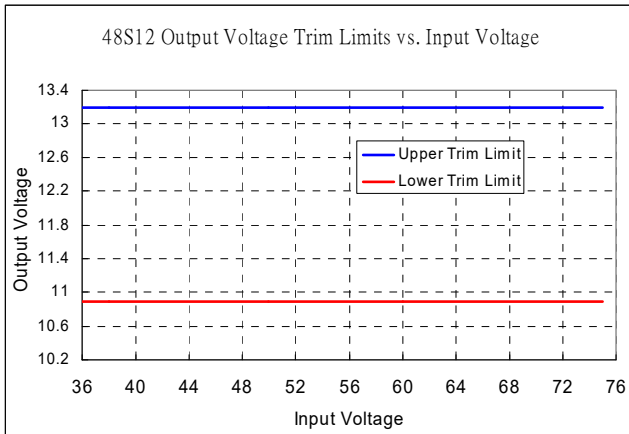

6.9 Output Remote Sensing

The CHB350 SERIES converter has the capability to remotely sense both lines of its output. This feature moves the effective output voltage regulation point from the output of the unit to the point of connection of the remote sense pins. This feature automatically adjusts the real output voltage of the CHB350 series in order to compensate for voltage drops in distribution and maintain a regulated voltage at the point of load. The remote-sense voltage range is:

$$[(+V_{out}) - (-V_{out})] - [(+Sense) - (-Sense)] \leq 10\% \text{ of } V_{o_nominal}$$

If the remote sense feature is not to be used, the sense pins should be connected locally. The +Sense pin should be connected to the +Vout pin at the module and the -Sense pin should be connected to the -Vout pin at the module.

This is shown in the schematic below.

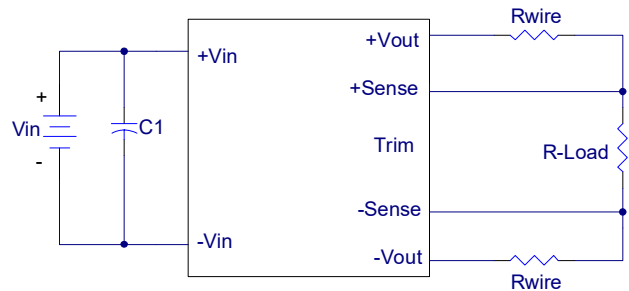

Note: Although the output voltage can be increased by both the remote sense and by the trim, the maximum increase for the output voltage is not the sum of both. The maximum increase is the larger of either the remote sense or the trim. The amount of power delivered by the module is defined as the voltage at the output terminals multiplied by the output current. When using remote sense and trim, the output voltage of the module can be increased and consequently increase the power output of the module if output current remains unchanged. Care should be taken to ensure that the maximum output power of the module remains at or below the maximum rated power (Maximum rated power = $V_{o,set} \times I_{o,max}$.)

6.10 Output Ripple and Noise

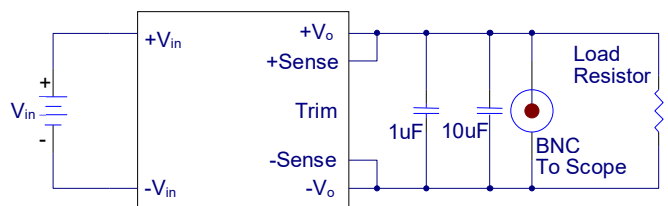

Output ripple and noise is measured with 1.0uF ceramic and 10uF solid tantalum capacitors across the output.

6.11 Output Capacitance

For good transient response, low ESR output capacitors should be located close to the point of load. PCB design emphasizes low resistance and inductance tracks in consideration of high current applications. Output capacitors with their associated ESR values have an impact on loop stability and bandwidth. For absolute maximum value of CHB350 series' output capacitance, please refer to **page 5 maximum output capacitance**. For values larger than this, please contact your local CINCON's representative.



CHB350 Series Application Note V17

7. Safety & EMC

7.1 Input Fusing and Safety Considerations

The CHB350 series converters have no internal fuse. In order to achieve maximum safety and system protection, always use an input line fuse. We recommended a 40A Fast blow type fuse for 24V_{in} models, and 20A for 48V_{in} models. It is recommended that the circuit have a transient voltage suppressor diode (TVS) across the input terminal to protect the unit against surge or spike voltage and input reverse voltage (as shown).

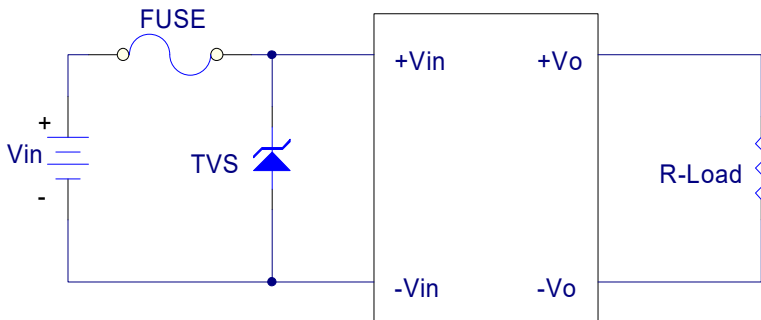

7.2 EMC Considerations

Suggested Circuits for Conducted EMI Class A & B

(1) EMI and conducted noise meet EN55032 Class A:

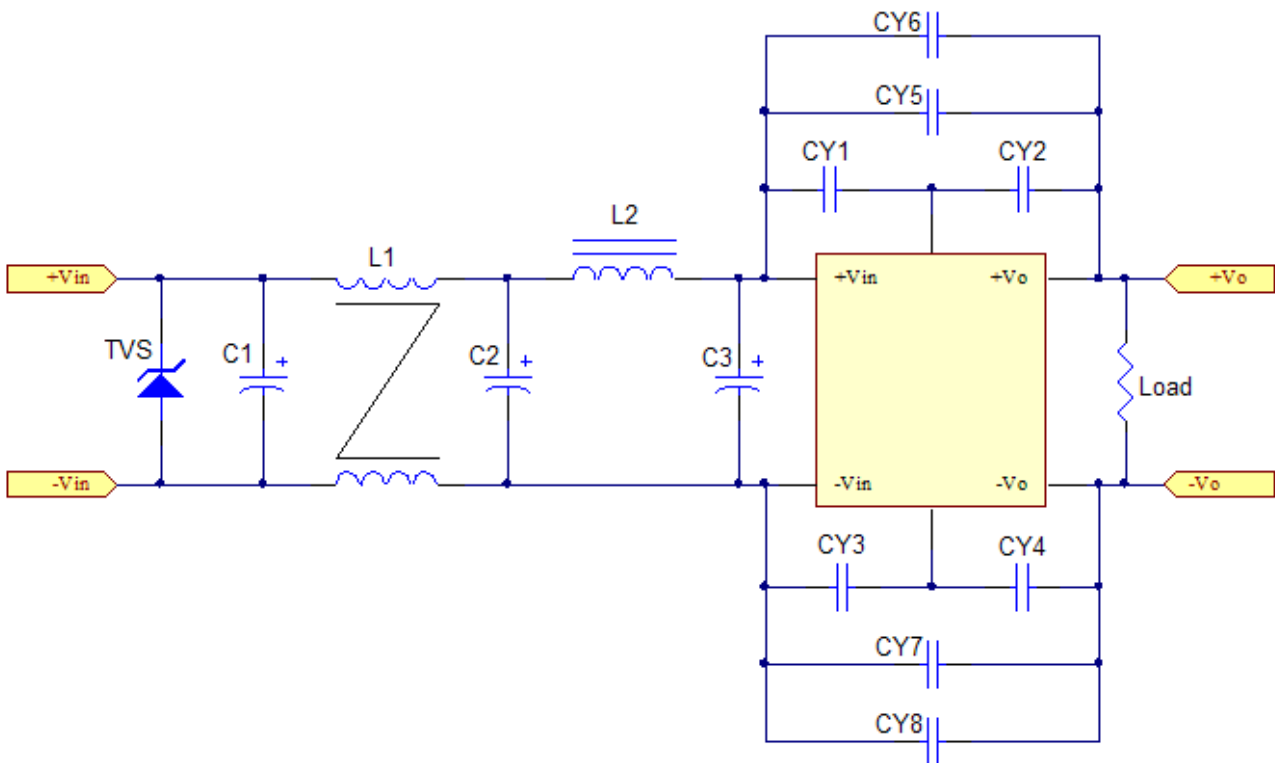



CHB350 Series Application Note V17

Model No.	Class A												
	C1	C2	C3	CY1	CY2	CY3	CY4	CY5	CY6	CY7	CY8	L1	L2
CHB350-24S3V3	220uF/100V	470uF/100V	NC	NC	NC	NC	NC	1000pF/2KV	NC	1000pF/2KV	NC	0.9mH	Short
CHB350-24S05	220uF/100V	470uF/100V	NC	NC	NC	NC	NC	1000pF/2KV	NC	1000pF/2KV	NC	0.9mH	Short
CHB350-24S12	220uF/100V	470uF/100V	NC	NC	NC	NC	NC	1000pF/2KV	NC	1000pF/2KV	NC	0.9mH	Short
CHB350-24S24	220uF/100V	470uF/100V	NC	NC	NC	NC	NC	1000pF/2KV	NC	1000pF/2KV	NC	0.9mH	Short
CHB350-24S28	220uF/100V	470uF/100V	NC	NC	NC	NC	NC	1000pF/2KV	NC	1000pF/2KV	NC	0.9mH	Short
CHB350-24S48	220uF/100V	470uF/100V	NC	NC	NC	NC	NC	1000pF/2KV	NC	1000pF/2KV	NC	0.9mH	Short
CHB350-48S3V3	100uF/100V	220uF/100V	NC	NC	NC	1000pF/2KV	1000pF/2KV	1000pF/2KV	NC	1000pF/2KV	NC	0.9mH	Short
CHB350-48S05	100uF/100V	220uF/100V	NC	NC	NC	1000pF/2KV	1000pF/2KV	1000pF/2KV	NC	1000pF/2KV	NC	0.9mH	Short
CHB350-48S12	100uF/100V	220uF/100V	NC	NC	NC	1000pF/2KV	1000pF/2KV	1000pF/2KV	NC	1000pF/2KV	NC	0.9mH	Short
CHB350-48S24	100uF/100V	220uF/100V	NC	NC	NC	1000pF/2KV	1000pF/2KV	1000pF/2KV	NC	1000pF/2KV	NC	0.9mH	Short
CHB350-48S28	100uF/100V	220uF/100V	NC	NC	NC	1000pF/2KV	1000pF/2KV	1000pF/2KV	NC	1000pF/2KV	NC	0.9mH	Short
CHB350-48S48	100uF/100V	220uF/100V	NC	NC	NC	1000pF/2KV	1000pF/2KV	1000pF/2KV	NC	1000pF/2KV	NC	0.9mH	Short

Note:

The 24SXX Models C1 NIPPON CHEMI-CON KY series aluminum capacitors

48SXX Models C1 NIPPON CHEMI-CON KMF series aluminum capacitors

24SXX Models C2 NICHICON PS series aluminum capacitors

48SXX Models C2 NIPPON CHEMI-CON KY series aluminum capacitors

CY3, CY4, CY5, CY7 is ceramic capacitors

(2) EMI and conducted noise meet EN55032 Class B:

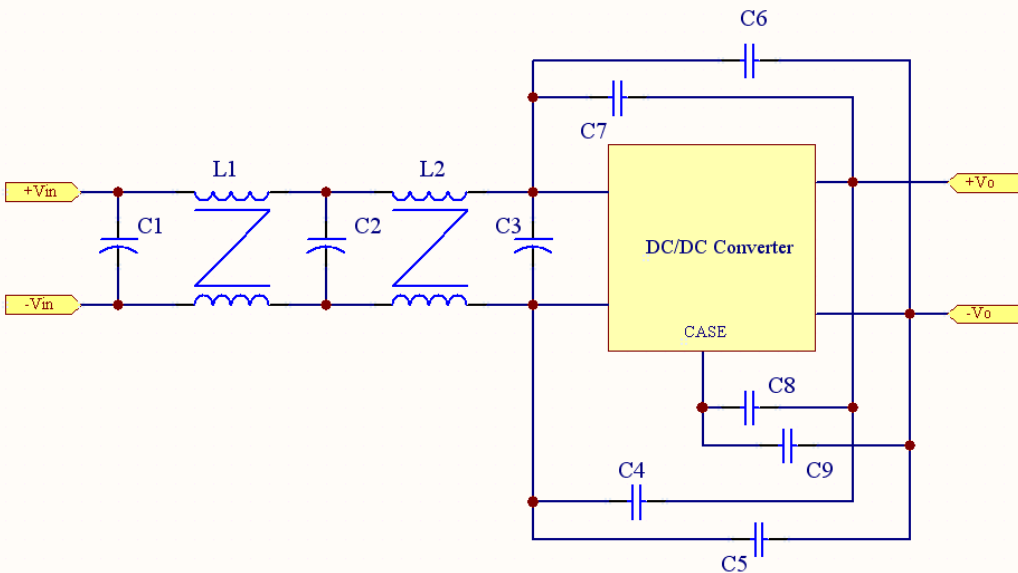

Model No.	Class B										
	C1	C2	C3	C4	C5	C6	C7	C8	C9	L1	L2
CHB350-24S12	470uF/100V	470uF/100V	470uF/100V	1000pF/2KV	2200pF/2KV	1000pF/2KV	2200pF/2KV	NC	NC	0.8mH	1.2mH
CHB350-24S48	470uF/100V	470uF/100V	470uF/100V	1000pF/2KV	2200pF/2KV	1000pF/2KV	2200pF/2KV	1000pF/2KV	1000pF/2KV	0.8mH	1.0mH
CHB350-48S12	470uF/100V	470uF/100V	470uF/100V	1000pF/2KV	2200pF/2KV	1000pF/2KV	2200pF/2KV	NC	NC	0.8mH	1.2mH

Note:

The C1, C2, C3 NIPPON CHEMI-CON KMF series aluminum capacitors, C4, C5, C6, C7, C8, C9 is ceramic capacitors



CHB350 Series Application Note V17

(3) EMI and conducted noise meet EN55032 Class B:

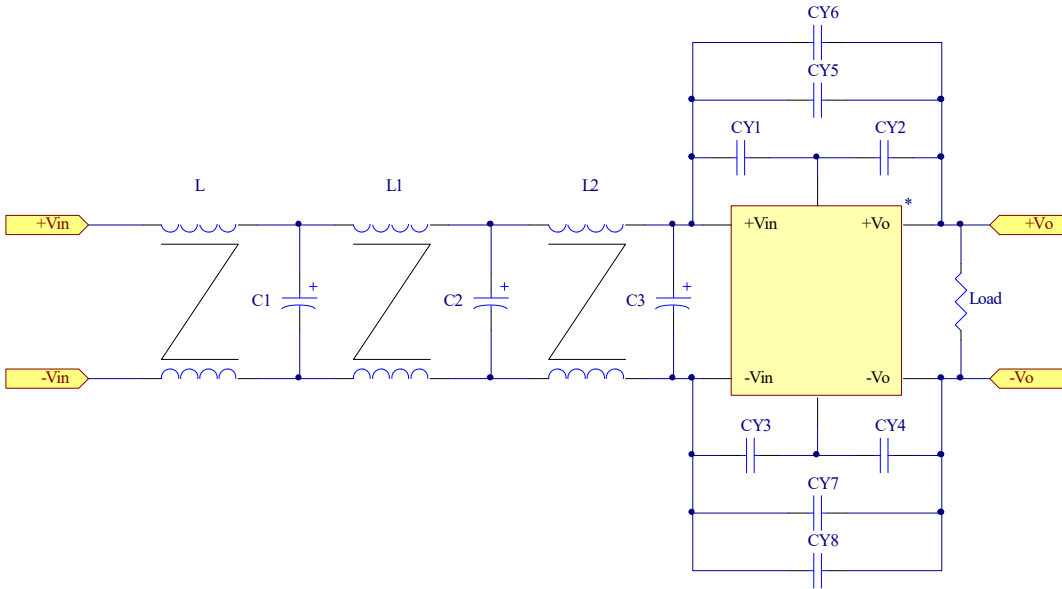

Model No.	Class B												L	L1	L2
	C1	C2	C3	CY1	CY2	CY3	CY4	CY5	CY6	CY7	CY8				
CHB350-24S3V3	470uF/100V	470uF/100V	470uF/100V	NC	NC	NC	NC	1000pF/2KV	NC	1000pF/2KV	NC	Short	0.9mH	0.9mH	
CHB350-24S05	470uF/100V	470uF/100V	470uF/100V	NC	NC	NC	NC	1000pF/2KV	NC	1000pF/2KV	NC	Short	0.9mH	0.9mH	
CHB350-24S28	470uF/100V	470uF/100V	470uF/100V	NC	NC	NC	1000pF/2KV	2200pF/2KV	NC	2200pF/2KV	NC	Short	0.9mH	0.9mH	
CHB350-48S3V3	470uF/100V	470uF/100V	470uF/100V	NC	NC	NC	NC	1000pF/2KV	1000pF/2KV	1000pF/2KV	1000pF/2KV	Short	0.9mH	0.9mH	
CHB350-48S05	470uF/100V	470uF/100V	470uF/100V	NC	NC	NC	NC	1000pF/2KV	1000pF/2KV	1000pF/2KV	1000pF/2KV	Short	0.9mH	0.9mH	

Note:

The C1, C2, C3 NICHICON PS series aluminum capacitors, C4, C5, C6, C7 is ceramic capacitors



CHB350 Series Application Note V17

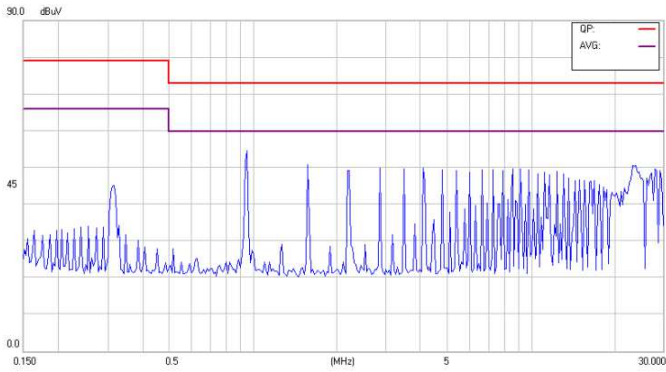

Conducted Class A of CHB350-24S3V3

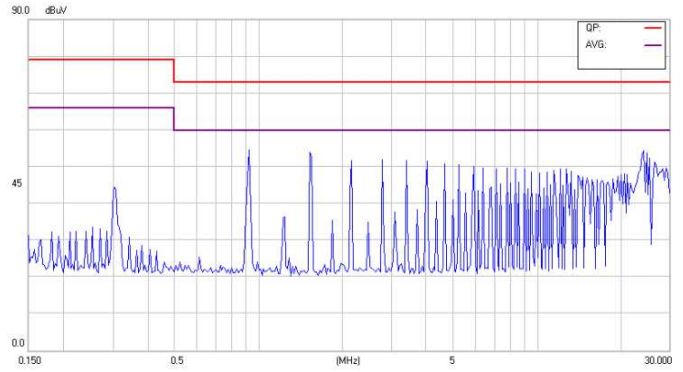

Conducted Class A of CHB350-24S05

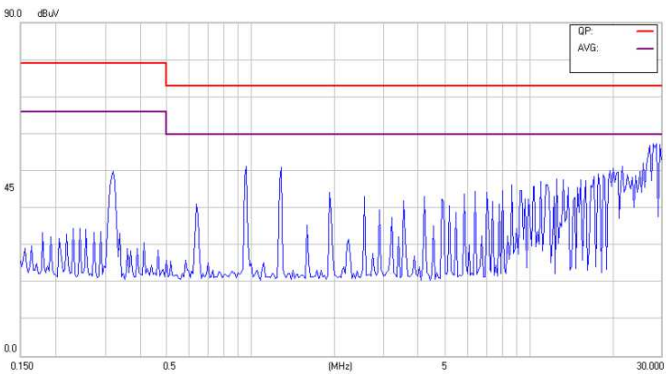

Conducted Class A of CHB350-24S12

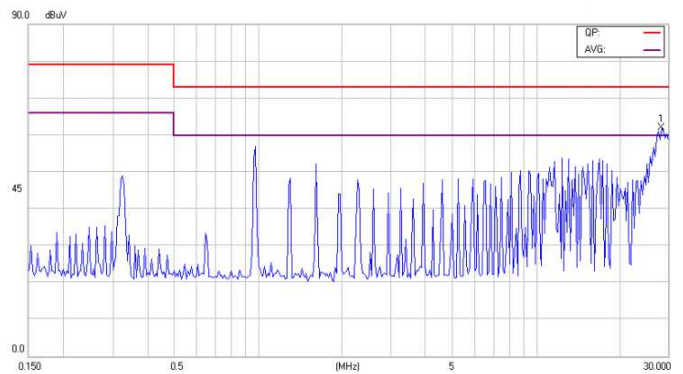

Conducted Class A of CHB350-24S24

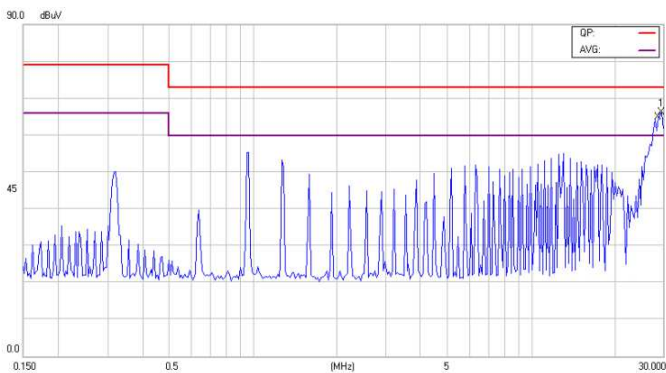

Conducted Class A of CHB350-24S28

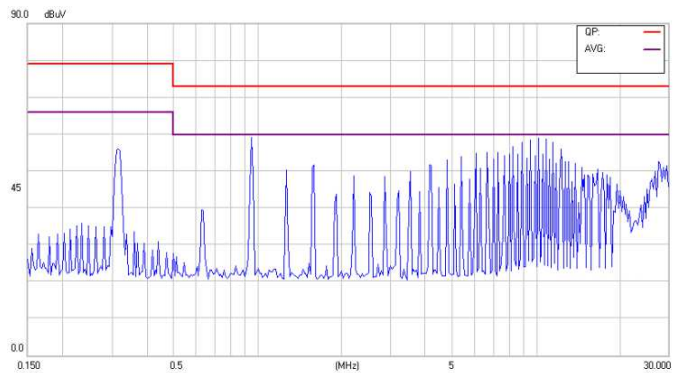

Conducted Class A of CHB350-24S48

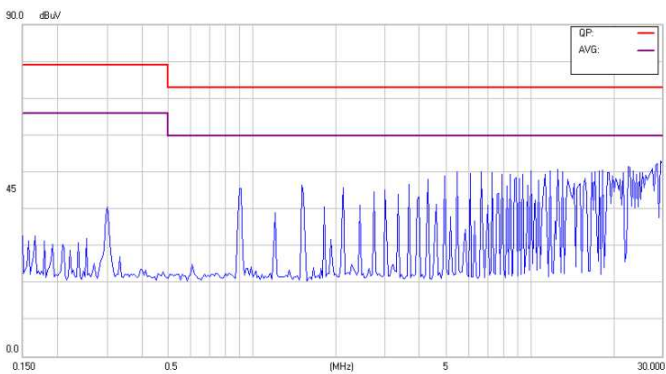

Conducted Class A of CHB350-48S3V3

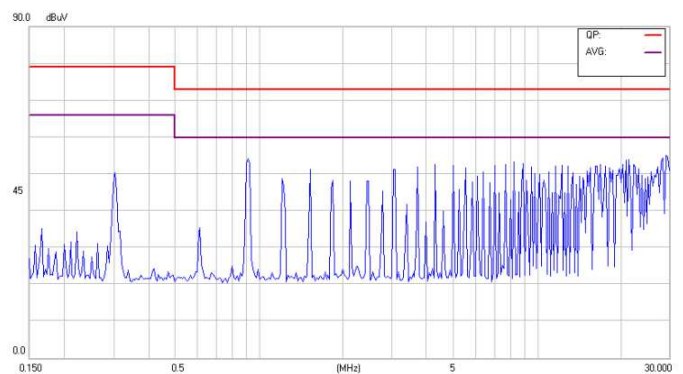

Conducted Class A of CHB350-48S05



CHB350 Series Application Note V17

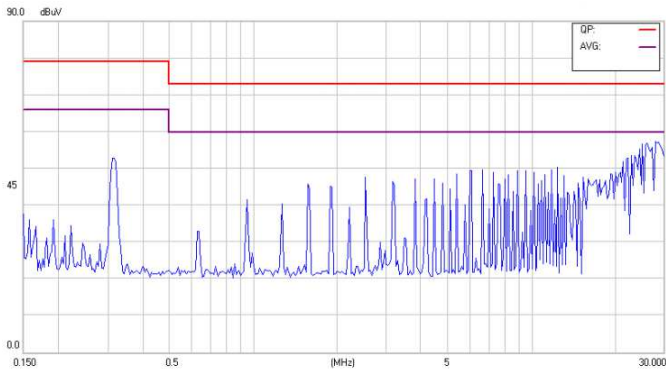

Conducted Class A of CHB350-48S12

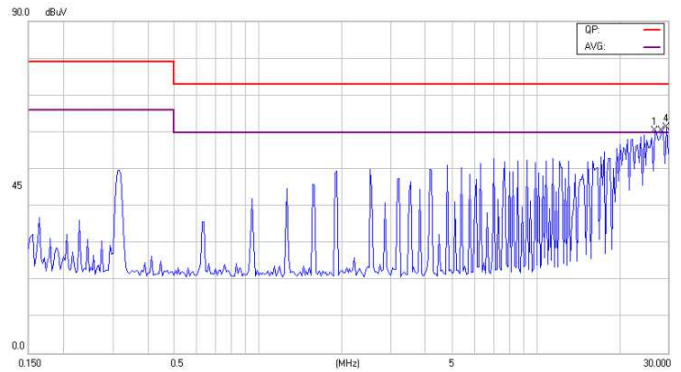

Conducted Class A of CHB350-48S24

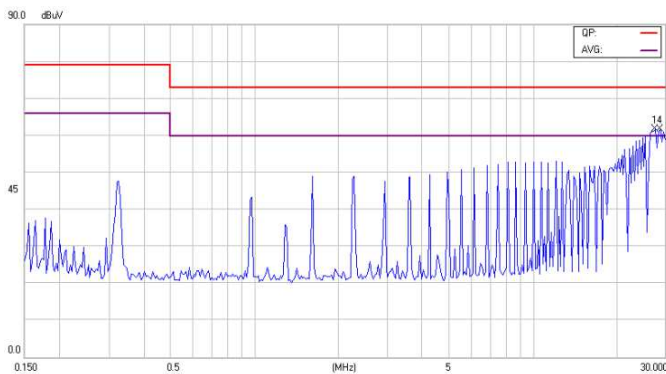

Conducted Class A of CHB350-48S28

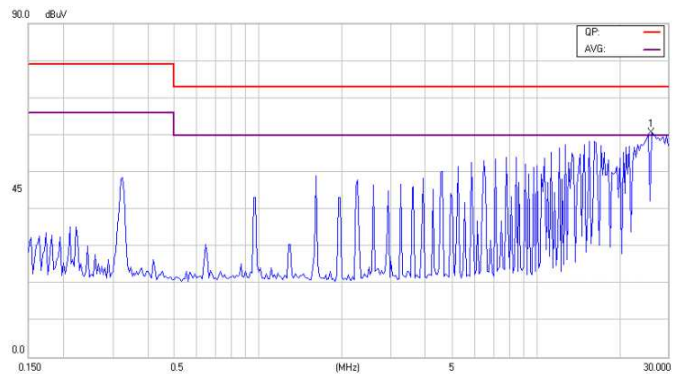

Conducted Class A of CHB350-48S48

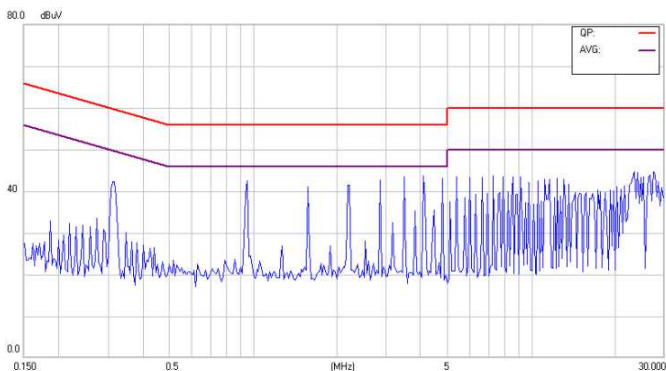

Conducted Class B of CHB350-24S3V3

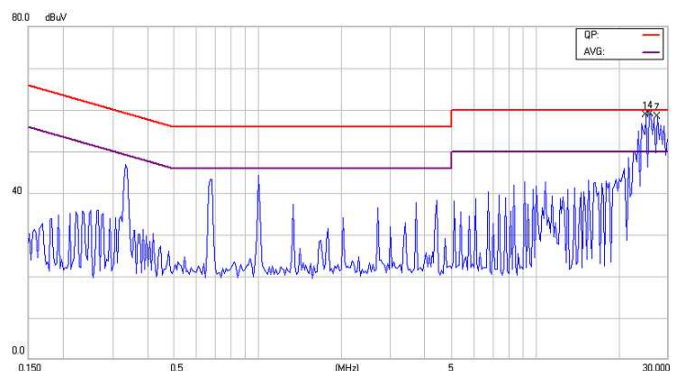

Conducted Class B of CHB350-24S12

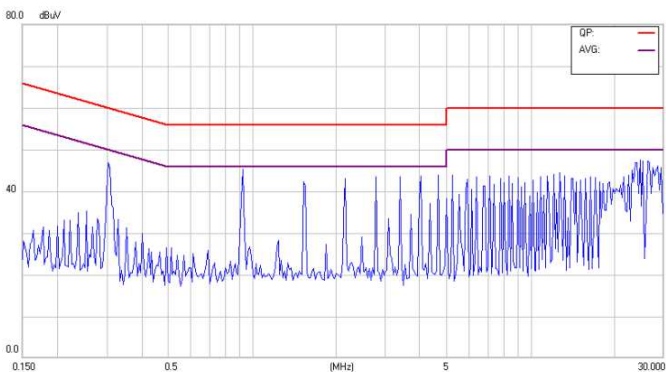

Conducted Class B of CHB350-24S05

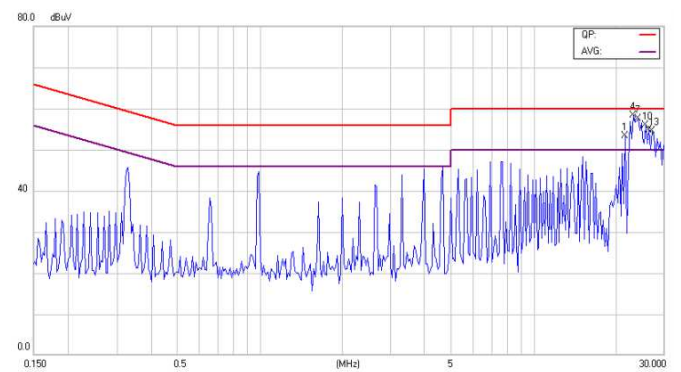

Conducted Class B of CHB350-24S28



CHB350 Series Application Note V17

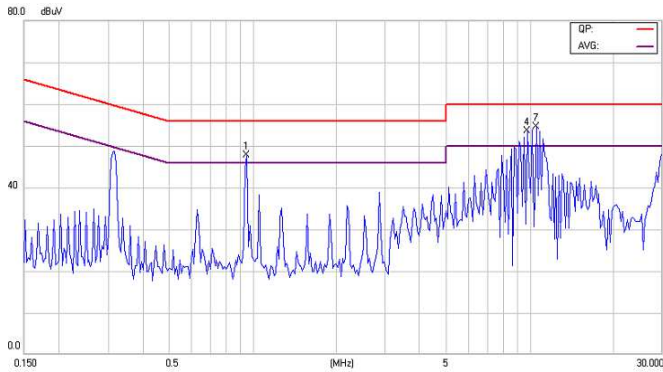

Conducted Class B of CHB350-24S48

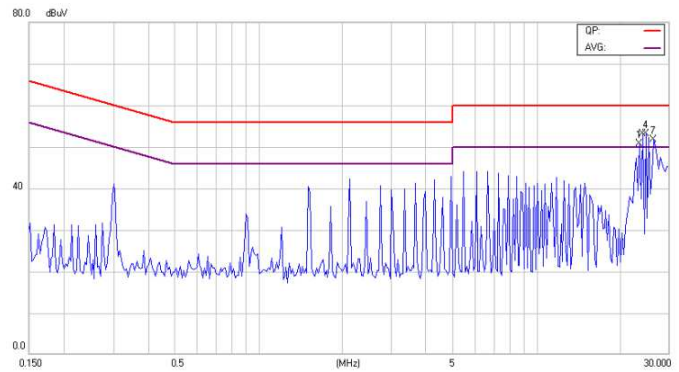

Conducted Class B of CHB350-48S3V3

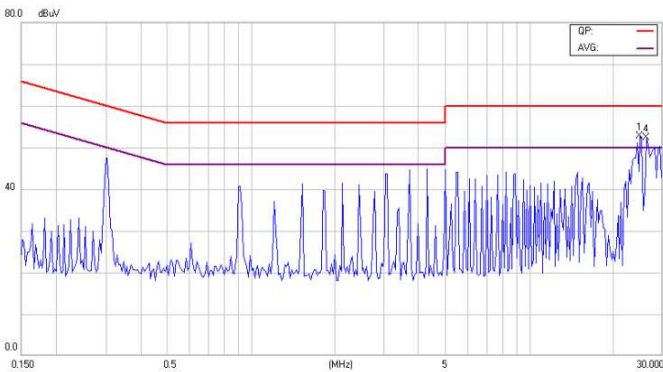

Conducted Class B of CHB350-48S05

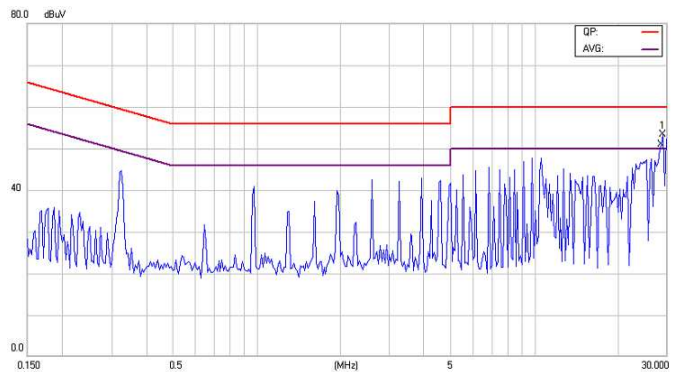

Conducted Class B of CHB350-48S12

8. Part Number

Format: CHB350 - II X 00 L-Y

Parameter	Series	Nominal Input Voltage	Number of Outputs	Output Voltage	Remote On/Off Logic	Option
Symbol	CHB350	II	X	OO	L	Y
Value	CHB350	24 : 24 Volts 48 : 48 Volts	S : Single	3V3 : 3.3 Volts 05 : 05 Volts 12 : 12 Volts 24 : 24 Volts 28 : 28 Volts 48 : 48 Volts	None : Positive N : Negative	C : Clear Mounting Insert I : Thin input pins IC : Thin input pins and Clear Mounting Insert L : Case High 12.7mm

CINCON ELECTRONICS CO., LTD.

Headquarters:

14F, No.306, Sec.4, Hsin Yi Rd.
Taipei, Taiwan
Tel: 886-2-27086210
Fax: 886-2-27029852
E-mail: sales@cincon.com
Web Site: <https://www.cincon.com>

Factory:

No. 8-1, Fu Kung Rd.
Fu Hsing Industrial Park
Fu Hsing Hsiang,
Chang Hua Hsien, Taiwan
Tel: 886-4-7690261
Fax: 886-4-7698031

Cincon North America:

1655 Mesa Verde Ave. Ste 180
Ventura, CA 93003
Tel: 805-639-3350
Fax: 805-639-4101
E-mail: info@cincon.com