



# EC3SBW 15W Isolated DC-DC Converters

## Application Note V14

### ISOLATED DC-DC Converter EC3SBW SERIES APPLICATION NOTE



#### Approved By:

Department	Approved By	Checked By	Written By
Research and Development Department	Jacky	Astray	Sean
Design Quality Department	Benny	JoJo	



# EC3SBW 15W Isolated DC-DC Converters

## Application Note V14

---

### Content

<b>1. INTRODUCTION</b>	<b>3</b>
<b>2. DC-DC CONVERTER FEATURES</b>	<b>3</b>
<b>3. ELECTRICAL BLOCK DIAGRAM</b>	<b>3</b>
<b>4. TECHNICAL SPECIFICATIONS</b>	<b>5</b>
<b>5. MAIN FEATURES AND FUNCTIONS</b>	<b>9</b>
5.1 Operating Temperature Range	9
5.2 Remote On/Off	9
5.3 UVLO (Under Voltage Lock Out)	9
5.4 Over Current Protection	9
5.5 Over Voltage Protection	9
<b>6. APPLICATIONS</b>	<b>9</b>
6.1 Recommended Layout PCB Footprints and Soldering Information	9
6.2 Power De-Rating Curves for EC3SBW Series	10
6.3 Efficiency vs. Load Curves	12
6.4 Input Capacitance at the Power Module	15
6.5 Test Set-Up	15
6.6 Output Voltage Adjustment	15
6.7 Output Ripple and Noise Measurement	17
6.8 Output Capacitance	17
<b>7. SAFETY &amp; EMC</b>	<b>18</b>
7.1 Input Fusing and Safety Considerations.	18
7.2 EMC Considerations	18
<b>8. PART NUMBER</b>	<b>21</b>
<b>9. MECHANICAL SPECIFICATIONS</b>	<b>21</b>



# EC3SBW 15W Isolated DC-DC Converters

## Application Note V14

### 1. Introduction

The EC3SBW series offer 15 watts of output power in a 1.00x1.00x0.4 inches copper packages. The EC3SBW series has a 4:1 wide input voltage range of 9-36 and 18-75VDC and provides a precisely regulated output. This series has features such as high efficiency, 1500VDC of isolation and allows an ambient operating temperature range of -40°C to 85°C (de-rating above 71°C). The modules are fully protected against input UVLO (under voltage lock out), output over-current, over-voltage protection and continuous short circuit conditions. Furthermore, the standard control functions include remote on/off and adjustable output voltage. All models are very suitable for distributed power architectures, telecommunications, battery operated equipment and industrial applications.

### 2. DC-DC Converter Features

- 15W Isolated Output
- 1"x1"x0.4" Shielded Metal Case
- Efficiency to 88%
- 4:1 Input Range
- Regulated Outputs
- Fixed Switching Frequency
- Input Under Voltage Protection
- Over Current Protection
- Remote On/Off
- Continuous Short Circuit Protection
- Without Tantalum Capacitors inside
- Safety Meets IEC/EN/UL 62368-1

### 3. Electrical Block Diagram

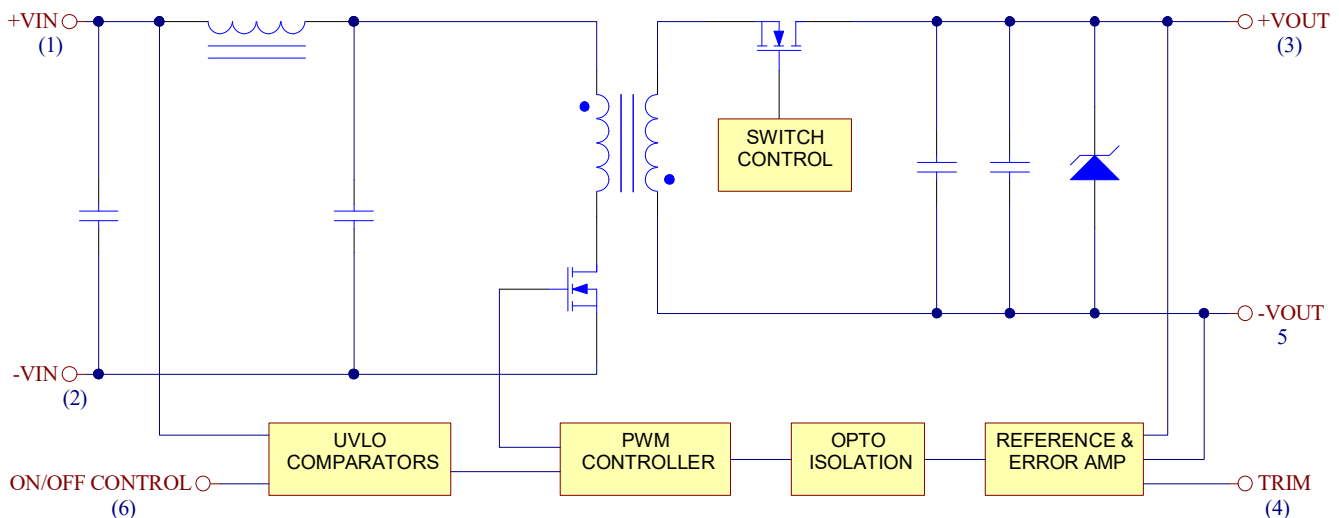

Figure1 Electrical Block Diagram of XXS33 and XXS05



# EC3SBW 15W Isolated DC-DC Converters

## Application Note V14

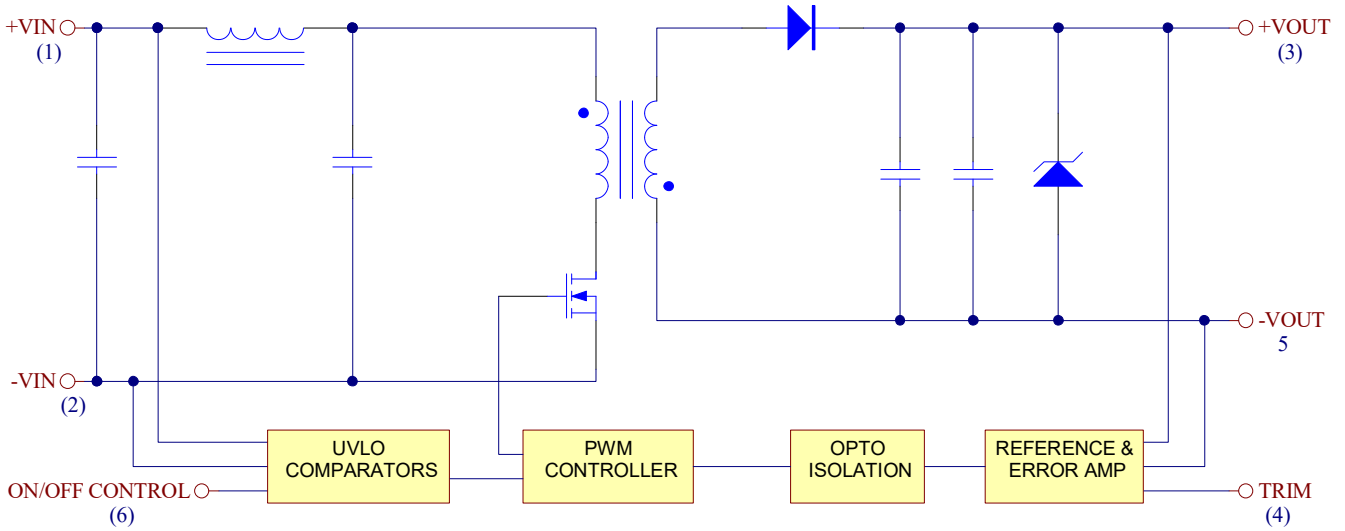

Figure2 Electrical Block Diagram of XXS12 and XXS15

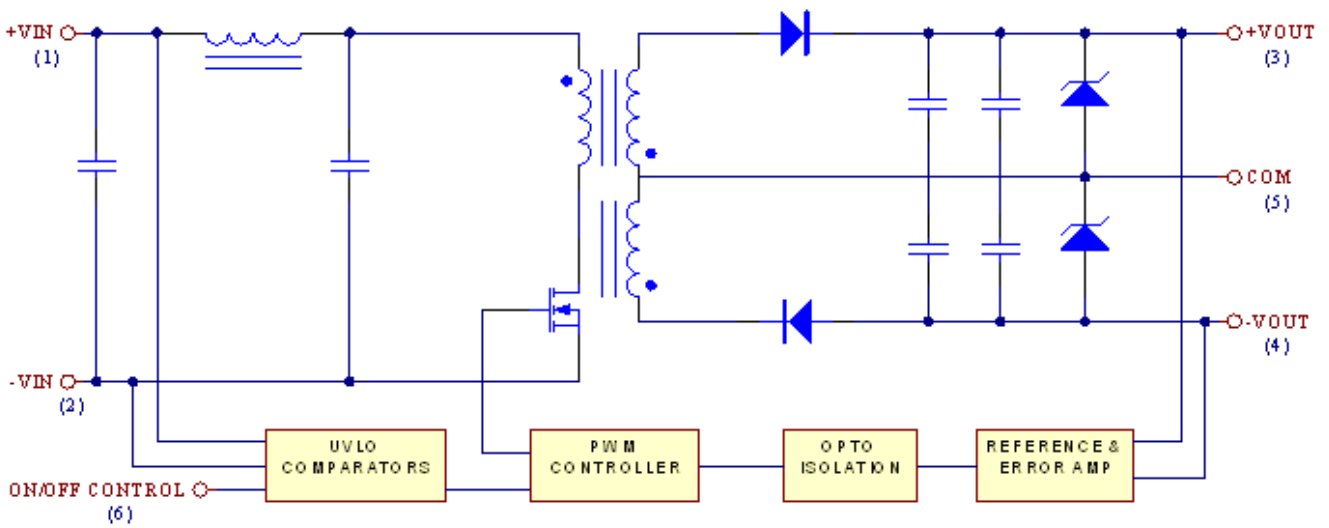

Figure3 Electrical Block Diagram of dual output module



# EC3SBW 15W Isolated DC-DC Converters

## Application Note V14

### 4. Technical Specifications

(All specifications are typical at nominal input, full load at 25°C unless otherwise noted.)

#### ABSOLUTE MAXIMUM RATINGS

PARAMETER	NOTES and CONDITIONS	Device	Min.	Typical	Max.	Units
Input Voltage						
Continuous		24V <sub>in</sub> 48V <sub>in</sub>	-0.3		36 75	V <sub>dc</sub>
Transient	100ms	24V <sub>in</sub> 48V <sub>in</sub>			50 100	V <sub>dc</sub>
Operating Ambient Temperature	Derating, above 71°C	All	-40		+85	°C
Case Temperature		All			105	°C
Storage Temperature		All	-55		+125	°C
Input/Output Isolation Voltage	1 Minute	All			1500	V <sub>dc</sub>

#### INPUT CHARACTERISTICS

PARAMETER	NOTES and CONDITIONS	Device	Min.	Typical	Max.	Units
Operating Input Voltage		24V <sub>in</sub> 48V <sub>in</sub>	9 18	24 48	36 75	V <sub>dc</sub>
Maximum Input Current	100% Load, V <sub>in</sub> =9V 100% Load, V <sub>in</sub> =18V	24V <sub>in</sub> 48V <sub>in</sub>			2100 1000	mA
No-Load Input Current	V <sub>in</sub> =Nominal input	24S33 24S05 24S12 24S15 24D05 24D12 24D15 48S33 48S05 48S12 48S15 48D05 48D12 48D15		60 70 30 30 30 30 30 40 40 20 20 20 20 20		mA
Off Converter Input Current	Shutdown input idle current	All		4	10	mA
Inrush Current (I <sup>2</sup> t)	As per ETS300 132-2	All			0.1	A <sup>2</sup> s
Input Reflected-Ripple Current	P-P thru 12uH inductor, 5Hz to 20MHz	All			30	mA



# EC3SBW 15W Isolated DC-DC Converters

## Application Note V14

### OUTPUT CHARACTERISTIC

PARAMETER	NOTES and CONDITIONS	Device	Min.	Typical	Max.	Units
Output Voltage Set Point	$V_{in} = \text{Nominal } V_{in}, I_o = I_{o, \text{max.}}, T_c = 25^\circ\text{C}$	$V_o = 3.3\text{V}$	3.2505	3.3	3.3495	$V_{dc}$
		$V_o = 5\text{V}$	4.925	5	5.075	
		$V_o = 12\text{V}$	11.82	12	12.18	
		$V_o = 15\text{V}$	14.775	15	15.225	
		$V_o = \pm 5\text{V}$	4.925	5	5.075	
		$V_o = \pm 12\text{V}$	11.82	12	12.18	
		$V_o = \pm 15\text{V}$	14.775	15	15.225	
Output Voltage Balance	$V_{in} = \text{Nominal}, I_o = I_{o, \text{max.}}, T_c = 25^\circ\text{C}$	Dual			$\pm 2.0$	%
Output Voltage Regulation						
Load Regulation	$I_o = \text{Full load to min. load}$	Single			$\pm 0.2$	%
		Dual			$\pm 1.0$	
Line Regulation	$V_{in} = \text{High line to low line full load}$	Single			$\pm 0.2$	%
		Dual			$\pm 0.5$	
Cross Regulation	Load cross variation 10%/100%	Dual			$\pm 5$	%
Temperature Coefficient	$T_c = -40^\circ\text{C to } 85^\circ\text{C}$	All			$\pm 0.03$	%/ $^\circ\text{C}$
Output Voltage Ripple and Noise 5Hz to 20MHz Bandwidth						
Peak-to-Peak	Full load, 20MHz bandwidth 10uF tantalum and 1uF ceramic capacitor	$V_o = 3.3\text{V}$			75	mV
		$V_o = 5\text{V}$			75	
		$V_o = 12\text{V}$			75	
		$V_o = 15\text{V}$			100	
		$V_o = \pm 5\text{V}$			100	
		$V_o = \pm 12\text{V}$			100	
		$V_o = \pm 15\text{V}$			100	
Operating Output Current Range		$V_o = 3.3\text{V}$	0		4000	mA
		$V_o = 5\text{V}$	0		3000	
		$V_o = 12\text{V}$	0		1250	
		$V_o = 15\text{V}$	0		1000	
		$V_o = \pm 5\text{V}$	0		$\pm 1500$	
		$V_o = \pm 12\text{V}$	0		$\pm 625$	
		$V_o = \pm 15\text{V}$	0		$\pm 500$	
Output DC Current-Limit Inception	Output voltage = 90% $V_{o, \text{nominal}}$	All	110	140	175	%
Maximum Output Capacitance	Full load, resistance	$V_o = 3.3\text{V}$			4000	$\mu\text{F}$
		$V_o = 5\text{V}$			3000	
		$V_o = 12\text{V}$			1250	
		$V_o = 15\text{V}$			1000	
		$V_o = \pm 5\text{V}$			1500	
		$V_o = \pm 12\text{V}$			625	
		$V_o = \pm 15\text{V}$			470	



# EC3SBW 15W Isolated DC-DC Converters

## Application Note V14

### DYNAMIC CHARACTERISTICS

PARAMETER	NOTES and CONDITIONS	Device	Min.	Typical	Max.	Units
Output Voltage Current Transient						
Step Change in Output Current	75% to 100% of $I_{o,max}$ .	All			±5	%
Setting Time (within 1% $V_{o,nominal}$ )	$di/dt=0.1A/us$	All			250	us
Turn-On Delay and Rise Time						
Turn-On Delay Time, From On/Off Control	$V_{on/off}$ to 10% $V_{o,set}$	All		10		ms
Turn-On Delay Time, From Input	$V_{in,min.}$ to 10% $V_{o,set}$	All		10		ms
Output Voltage Rise Time	10% $V_{o,set}$ to 90% $V_{o,set}$	All		10		ms

### EFFICIENCY

PARAMETER	NOTES and CONDITIONS	Device	Min.	Typical	Max.	Units
100% Load	$V_{in}=\text{Nominal } V_{in}, I_o=I_{o,max.}, T_c=25^{\circ}C$	24S33		87		%
		24S05		87		
		24S12		87		
		24S15		88		
		24D05		85		
		24D12		87		
		24D15		88		
		48S33		88		
		48S05		88		
		48S12		87		
		48S15		87		
		48D05		85		
		48D12		87		
48D15		87				

### ISOLATION CHARACTERISTICS

PARAMETER	NOTES and CONDITIONS	Device	Min.	Typical	Max.	Units
Input to Output	1 Minutes	All			1500	$V_{dc}$
Isolation Resistance		All	1000			MΩ
Isolation Capacitance		All		1000		pF

### FEATURE CHARACTERISTICS

PARAMETER	NOTES and CONDITIONS	Device	Min.	Typical	Max.	Units
Switching Frequency		All		400		KHz
On/Off Control, Positive Remote On/Off Logic						
Logic Low (Module Off)	$V_{on/off}$ at $I_{on/off}=1.0mA$	All	0		1.2	V
Logic High (Module On)	$V_{on/off}$ at $I_{on/off}=0.1uA$	All	3.5 or Open Circuit		75	V



# EC3SBW 15W Isolated DC-DC Converters

## Application Note V14

PARAMETER	NOTES and CONDITIONS	Device	Min.	Typical	Max.	Units
Switching Frequency		All		400		KHz
On/Off Current (for Both Remote On/Off Logic)	$I_{on/off}$ at $V_{on/off}=0.0V$	All		0.3	1	mA
Leakage Current (for Both Remote On/Off Logic)	Logic high, $V_{on/off}=15V$	All			30	uA
Off Converter Input Current	Shutdown input idle current	All		4	10	mA
Output Voltage Trim Range	$P_{out}$ =max rated power	Single	-10		+10	%
Output Over Voltage Protection	Zener or TVS Clamp	$V_o=3.3V$ $V_o=5V$ $V_o=12V$ $V_o=15V$ $V_o=\pm 5V$ $V_o=\pm 12V$ $V_o=\pm 15V$		3.9 6.2 15 18 $\pm 6.2$ $\pm 15$ $\pm 18$		Vdc

### GENERAL SPECIFICATIONS

PARAMETER	NOTES and CONDITIONS	Device	Min.	Typical	Max.	Units
MTBF	$I_o=100\%$ of $I_{o,max.}$ ; $T_a=25^\circ C$ per MIL-HDBK-217F	S33&S05 Others		950 1300		K hours
Weight		All		18		grams





# EC3SBW 15W Isolated DC-DC Converters

## Application Note V14

### 5. Main Features and Functions

#### 5.1 Operating Temperature Range

The EC3SBW series converters can be operated by a wide ambient temperature range from -40°C to 85°C (de-rating above 71°C). The standard model has a Copper case and case temperature can not over 105°C at normal operating.

#### 5.2 Remote On/Off

The EC3SBW series allows the user to switch the module on and off electronically with the remote on/off feature. All models are available in “positive logic” versions. The converter turns on if the remote on/off pin is high (>3.5Vdc or open circuit). Setting the pin low (0 to <1.2Vdc) will turn the converter off. The signal level of the remote on/off input is defined with respect to ground. If not using the remote on/off pin, leave the pin open (converter will be on).

#### 5.3 UVLO (Under Voltage Lock Out)

Input under voltage lockout is standard on the EC3SBW unit. The unit will shut down when the input voltage drops below a threshold, and the unit will operate when the input voltage goes above the upper threshold.

#### 5.4 Over Current Protection

All models have internal over current and continuous short circuit protection. The unit operates normally once the fault condition is removed. At the point of current limit inception, the converter will go into hiccup mode protection.

#### 5.5 Over Voltage Protection

The over-voltage protection consists of a zener diode to limiting the out voltage.

### 6. Applications

#### 6.1 Recommended Layout PCB Footprints and Soldering Information

The system designer or the end user must ensure that other components and metal in the vicinity of the converter meet the spacing requirements to which the system is approved. Low resistance and low inductance PCB layout traces are the norm and should be used where possible. Due consideration must also be given to proper low impedance tracks between power module, input and output grounds. The recommended footprints and soldering profiles are shown as Figure4.

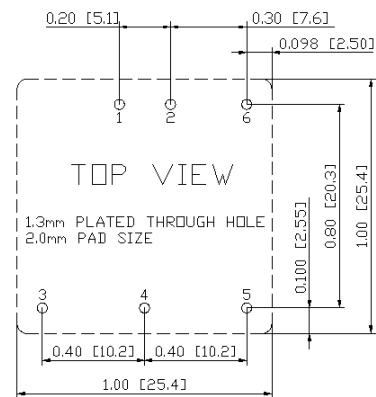

Note: Dimensions are in inches (millimeters)

Lead Free Wave Soldering Profile

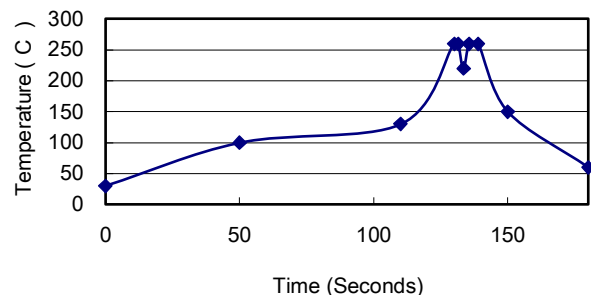

Note :

1. Soldering Materials: Sn/Cu/Ni
2. Ramp up rate during preheat: 1.4°C/Sec (From 50°C to 100°C)
3. Soaking temperature: 0.5°C/Sec (From 100°C to 130°C), 60±20 seconds
4. Peak temperature: 260°C, above 250°C 3~6 Seconds
5. Ramp up rate during cooling: -10.0°C/Sec (From 260°C to 150°C)

Figure4 Recommended PCB Layout Footprints and Wave Soldering Profiles for SB packages



# EC3SBW 15W Isolated DC-DC Converters

## Application Note V14

### 6.2 Power De-Rating Curves for EC3SBW Series

Operating Ambient Temperature Range :  $-40^{\circ}\text{C} \sim 85^{\circ}\text{C}$  (Drating Above  $71^{\circ}\text{C}$ ).

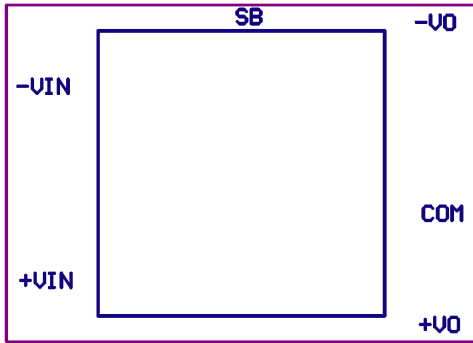

Top Overlay

Thermal test board top

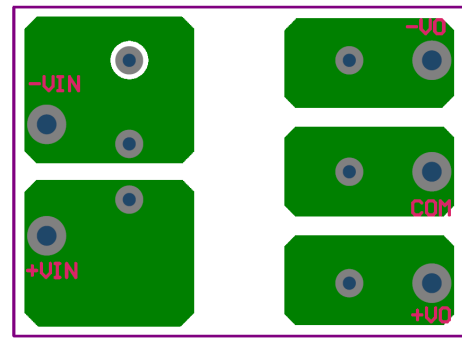

Bottom Layer

Thermal test board bottom

Maximum case temperature under any operating condition should not exceed  $105^{\circ}\text{C}$ .

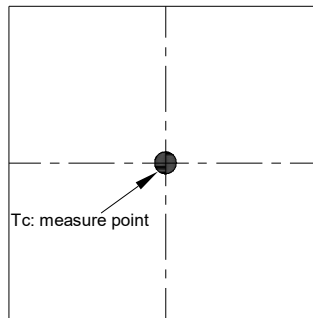



# EC3SBW 15W Isolated DC-DC Converters

## Application Note V14

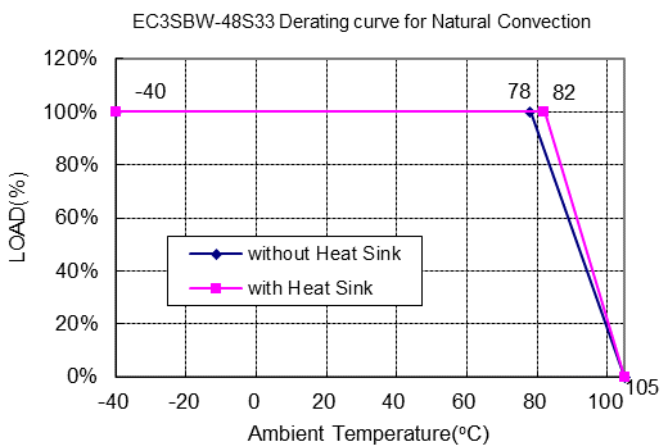
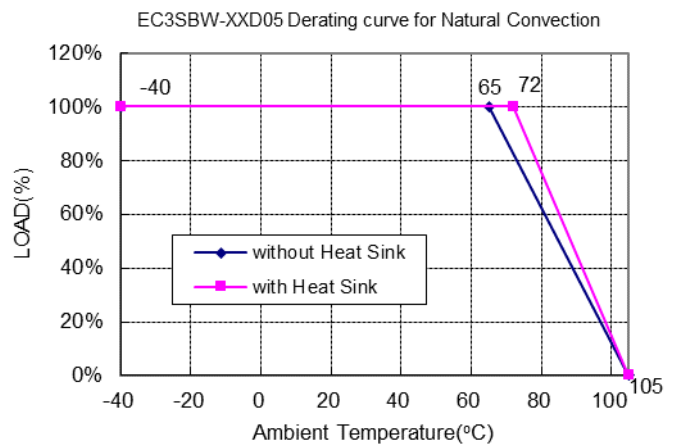
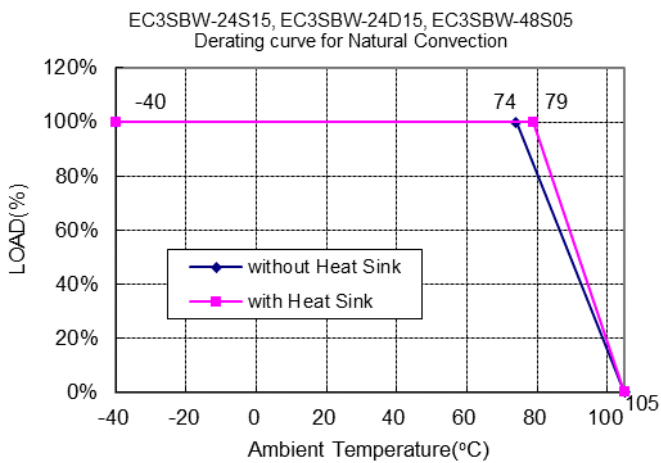
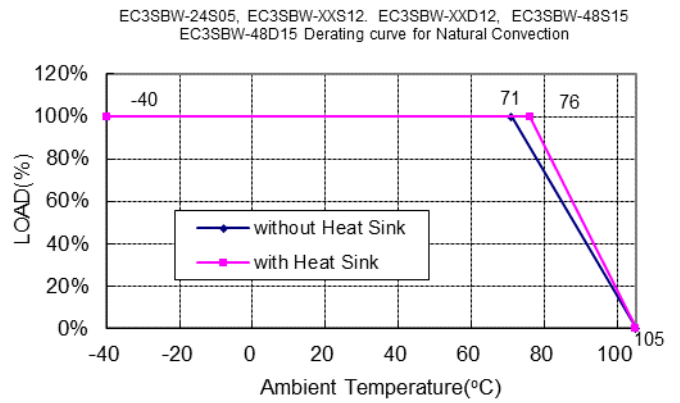
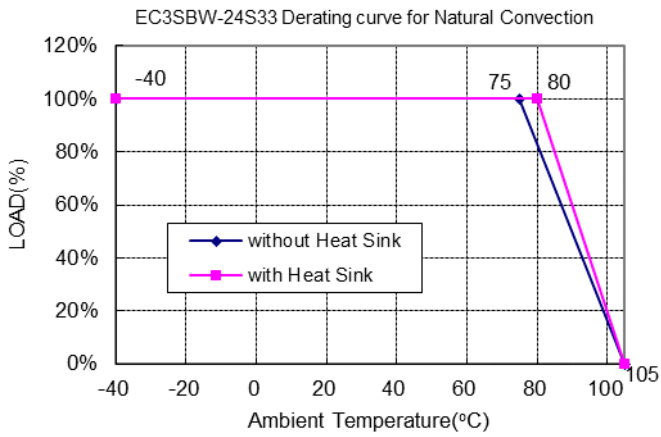



# EC3SBW 15W Isolated DC-DC Converters

## Application Note V14

### 6.3 Efficiency vs. Load Curves

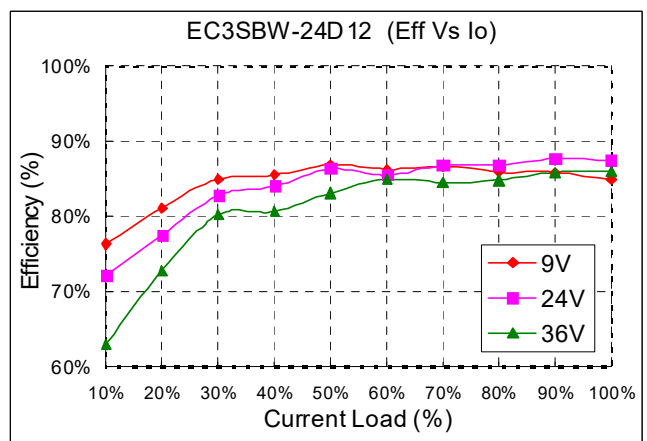
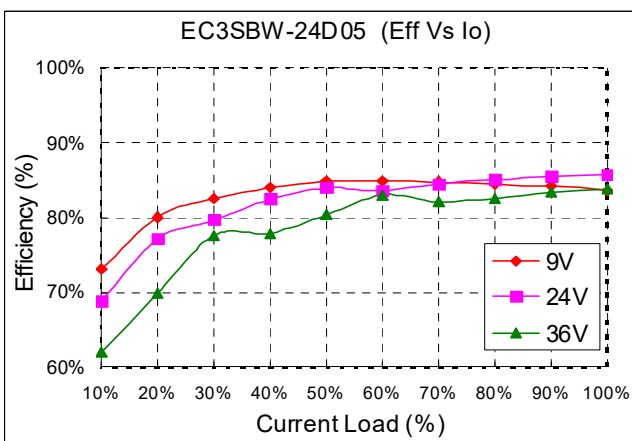
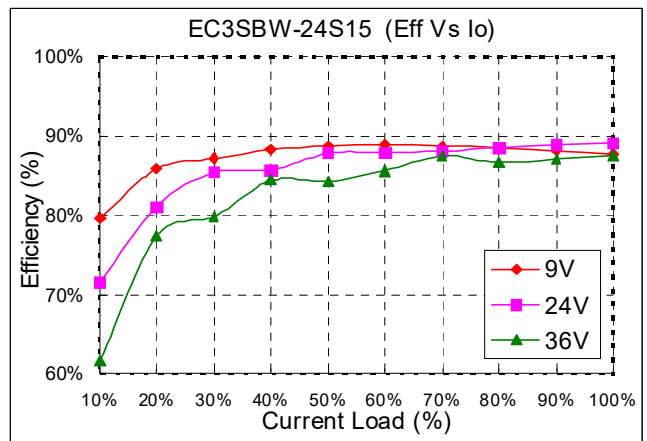
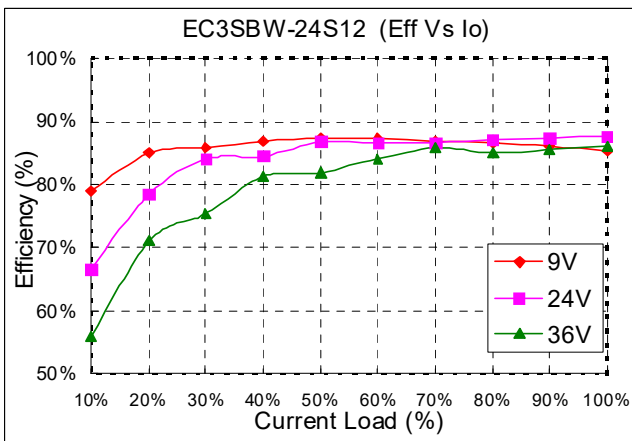
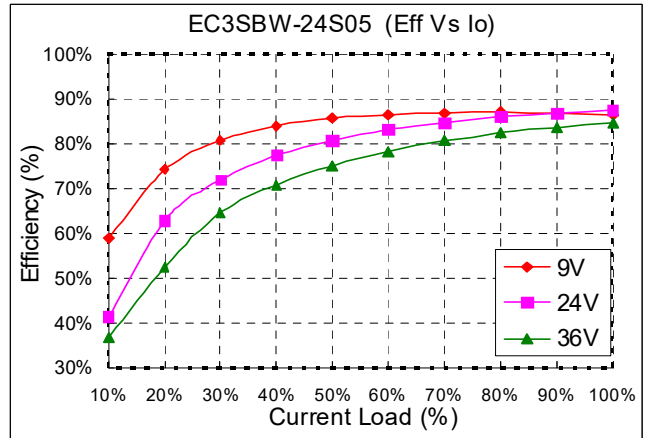
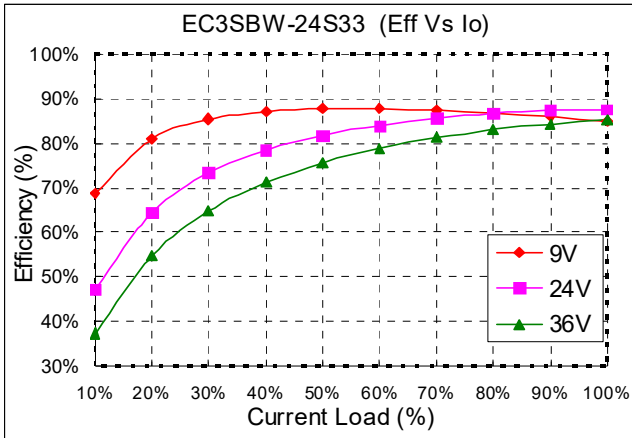



# EC3SBW 15W Isolated DC-DC Converters

## Application Note V14

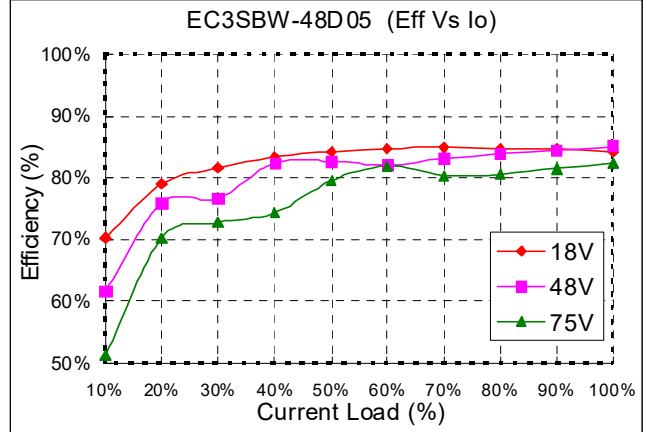
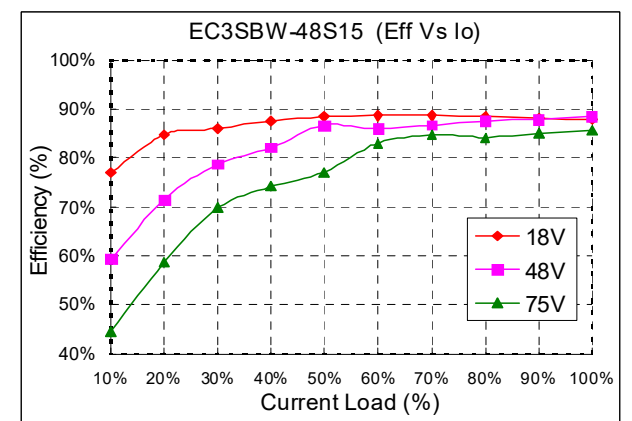
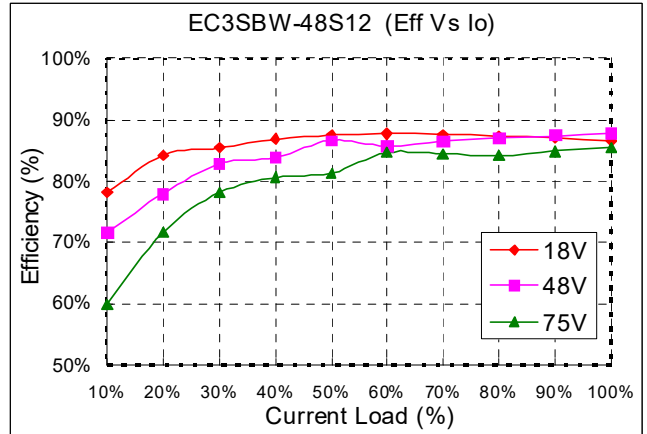
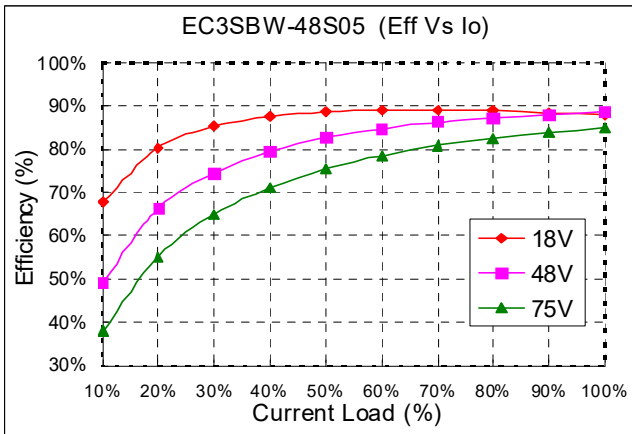
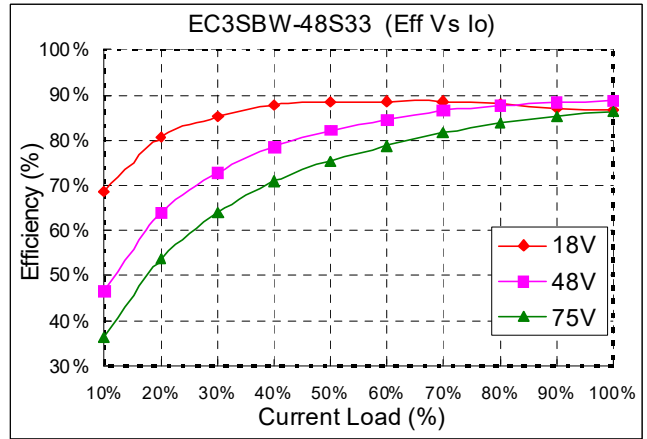
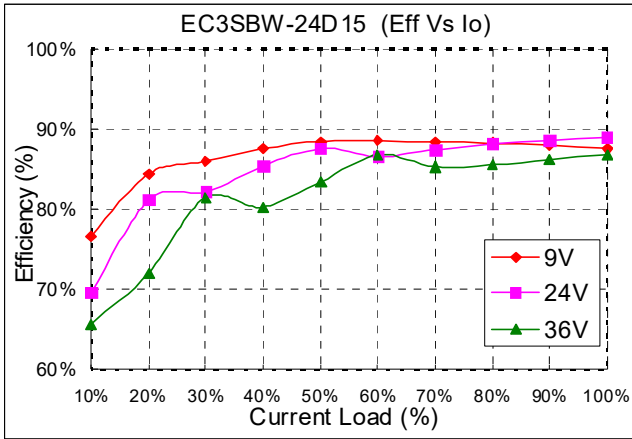



# EC3SBW 15W Isolated DC-DC Converters

## Application Note V14

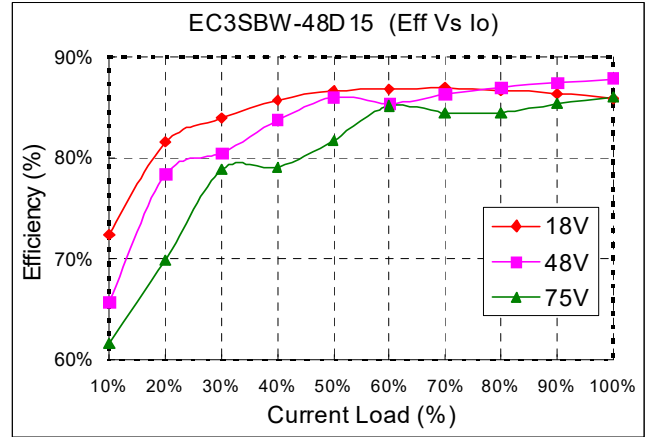
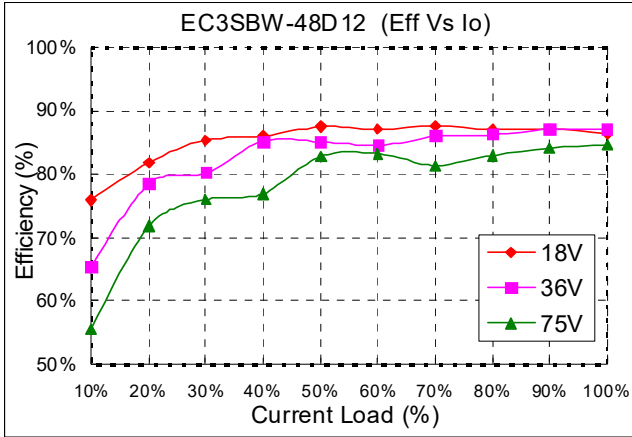



# EC3SBW 15W Isolated DC-DC Converters

## Application Note V14

### 6.4 Input Capacitance at the Power Module

The converters must be connected to low AC source impedance. To avoid problems with loop stability source inductance should be low. Also, the input capacitors (Cin) should be placed close to the converter input pins to de-couple distribution inductance. However, the external input capacitors are chosen for suitable ripple handling capability. Low ESR capacitors are good choice. Circuit as shown in Figure5 represents typical measurement methods for reflected ripple current. C1 and L1 simulate a typical DC source impedance. The input reflected-ripple current is measured by current probe to oscilloscope with a simulated source Inductance (L1)

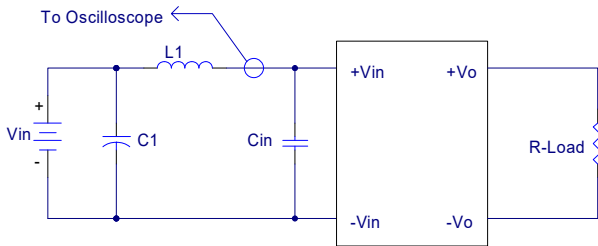

L1: 12uH  
 C1: None  
 Cin: 33uF ESR<0.7ohm @100KHz  
 Figure5 Input Reflected-Ripple Test Setup

### 6.5 Test Set-Up

The basic test set-up to measure parameters such as efficiency and load regulation is shown in Figure6. When testing the modules under any transient conditions please ensure that the transient response of the source is sufficient to power the equipment under test. We can calculate the

- Efficiency
- Load regulation and line regulation

The value of efficiency is defined as:

$$\eta = \frac{V_O \times I_O}{V_{IN} \times I_{IN}} \times 100\%$$

Where

V<sub>O</sub> is output voltage,  
 I<sub>O</sub> is output current,  
 V<sub>IN</sub> is input voltage,  
 I<sub>IN</sub> is input current.

The value of load regulation is defined as:

$$Load.reg = \frac{V_{FL} - V_{NL}}{V_{NL}} \times 100\%$$

Where

V<sub>FL</sub> is the output voltage at full load  
 V<sub>NL</sub> is the output voltage at 10% load

The value of line regulation is defined as:

$$Line.reg = \frac{V_{HL} - V_{LL}}{V_{LL}} \times 100\%$$

Where

V<sub>HL</sub> is the output voltage of maximum input voltage at full load.  
 V<sub>LL</sub> is the output voltage of minimum input voltage at full load.

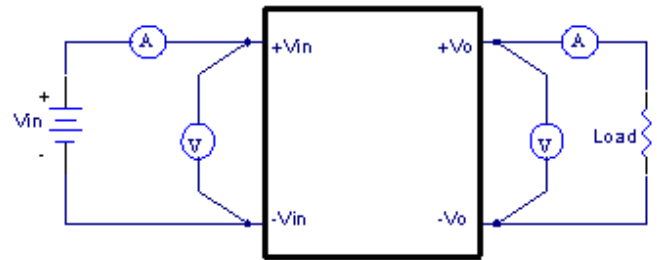

Figure6 EC3SBW Series Test Setup

### 6.6 Output Voltage Adjustment

In order to trim the voltage up or down one needs to connect the trim resistor either between the trim pin and -Vo for trim-up and between trim pin and +Vo for trim-down. The output voltage trim range is ±10%. This is shown in Figures 7 and 8:

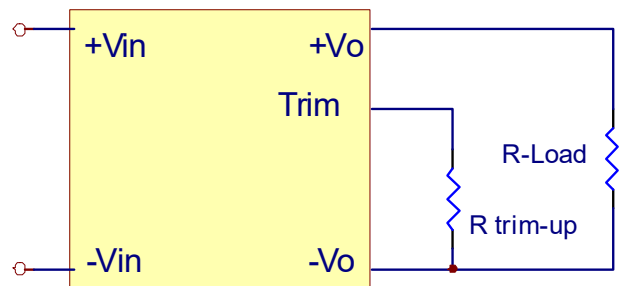

Figure7 Trim-up Voltage Setup

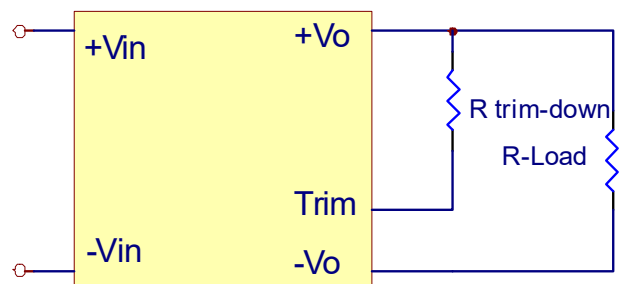

Figure8 Trim-down Voltage Setup



# EC3SBW 15W Isolated DC-DC Converters

## Application Note V14

### 1. The value of Rtrim-up defined as:

$$R_{trim-up} = \left( \frac{V_r \times R1 \times (R2 + R3)}{(V_o - V_{o,nom}) \times R2} \right) - R_t \text{ (K}\Omega\text{)}$$

Where

R<sub>trim-up</sub> is the external resistor in Kohm.

V<sub>o,nom</sub> is the nominal output voltage.

V<sub>o</sub> is the desired output voltage.

R1, R<sub>t</sub>, R2, R3 and V<sub>r</sub> are internal to the unit and are defined in Table 1.

Table 1 – Trim up and Trim down Resistor Values

Model Number	Output Voltage(V)	R1 (KΩ)	R2 (KΩ)	R3 (KΩ)	Rt (KΩ)	Vr (V)
EC3SBW24S33 EC3SBW48S33	3.3	2.74	1.8	0.27	9.1	1.24
EC3SBW24S05 EC3SBW48S05	5.0	2.32	2.32	0	8.2	2.5
EC3SBW24S12 EC3SBW48S12	12.0	6.8	2.4	2.32	22	2.5
EC3SBW24S15 EC3SBW48S15	15.0	8.06	2.4	3.9	27	2.5

For example, to trim-up the output voltage of 5.0V module (EC3SBW-24S05) by 10% to 5.5V, R<sub>trim-up</sub> is calculated as follows:

$$V_o - V_{o,nom} = 5.5 - 5.0 = 0.5V$$

$$R1 = 2.32 \text{ K}\Omega$$

$$R2 = 2.32 \text{ K}\Omega$$

$$R3 = 0 \text{ K}\Omega$$

$$R_t = 8.2 \text{ K}\Omega,$$

$$V_r = 2.5 \text{ V}$$

$$R_{trim-up} = \left( \frac{2.5 \times 2.32 \times (2.32 + 0)}{0.5 \times 2.32} \right) - 8.2 = 3.4(\text{K}\Omega)$$

### 2.The value of R trim-down defined as:

$$R_{trim-down} = R1 \times \left( \frac{V_r \times R1}{(V_{o,nom} - V_o) \times R2} - 1 \right) - R_t \text{ (K}\Omega\text{)}$$

Where

R<sub>trim-down</sub> is the external resistor in Kohm.

V<sub>o,nom</sub> is the nominal output voltage.

V<sub>o</sub> is the desired output voltage.

R1, R<sub>t</sub>, R2, R3 and V<sub>r</sub> are internal to the unit and are defined in Table 1

For example, to trim-down the output voltage of 5.0V module (EC3SBW-12S05) by 10% to 4.5V, R<sub>trim-down</sub> is calculated as follows:

$$V_{o,nom} - V_o = 5.0 - 4.5 = 0.5V$$

$$R1 = 2.32 \text{ K}\Omega$$

$$R2 = 2.32 \text{ K}\Omega$$

$$R3 = 0 \text{ K}\Omega$$

$$R_t = 8.2 \text{ K}\Omega$$

$$V_r = 2.5 \text{ V}$$

$$R_{trim-down} = 2.32 \times \left( \frac{(2.5 \times 2.32)}{0.5 \times 2.32} - 1 \right) - 8.2 = 1.08 \text{ (K}\Omega\text{)}$$

### The typical value of R<sub>trim-up</sub>

	3.3V	5V	12V	15V
Trim up %	R <sub>trim-up</sub> (KΩ)			
1%	109.30	107.80	256.61	325.63
2%	50.10	49.80	117.31	149.31
3%	30.37	30.47	70.87	90.54
4%	20.50	20.80	47.65	61.16
5%	14.58	15.00	33.72	43.53
6%	10.63	11.13	24.44	31.77
7%	7.81	8.37	17.80	23.38
8%	5.70	6.30	12.83	17.08
9%	4.06	4.69	8.96	12.18
10%	2.74	3.40	5.86	8.26

### The typical value of R<sub>trim-down</sub>

	3.3V	5V	12V	15V
Trim down %	R <sub>trim-down</sub> (KΩ)			
1%	144.88	105.48	372.59	416.08
2%	66.52	47.48	171.89	190.51
3%	40.40	28.15	105.00	115.32
4%	27.34	18.48	71.55	77.72
5%	19.50	12.68	51.48	55.17
6%	14.28	8.81	38.10	40.13
7%	10.55	6.05	28.54	29.39
8%	7.75	3.98	21.37	21.33
9%	5.57	2.37	15.80	15.07
10%	3.83	1.08	11.34	10.05





# EC3SBW 15W Isolated DC-DC Converters

## Application Note V14

### 6.7 Output Ripple and Noise Measurement

The test set-up for noise and ripple measurements is shown in Figure9. A coaxial cable was used to prevent impedance mismatch reflections disturbing the noise readings at higher frequencies. Measurements are taken with output appropriately loaded and all ripple/noise specifications are from D.C. to 20MHz Band Width.

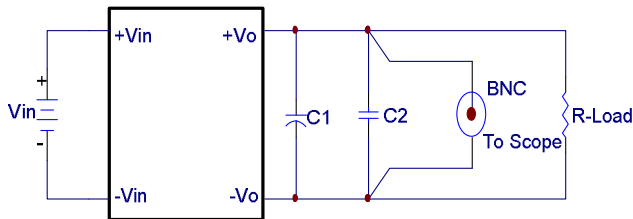

Note:

C1: 10uF tantalum capacitor

C2: 1uF Ceramic capacitor

Figure9 Output Voltage Ripple and Noise  
Measurement Set-Up

### 6.8 Output Capacitance

The EC3SBW series converters provide unconditional stability with or without external capacitors. For good transient response low ESR output capacitors should be located close to the point of load. These series converters are designed to work with load capacitance to see technical specifications.



# EC3SBW 15W Isolated DC-DC Converters

## Application Note V14

### 7. Safety & EMC

#### 7.1 Input Fusing and Safety Considerations.

The EC3SBW series converters have not an internal fuse. However, to achieve maximum safety and system protection, always use an input line fuse. We recommended a fast acting fuse 3.15A for 24Vin models and 1.5A for 48Vin models. Figure10 circuit is recommended by a Transient Voltage Suppressor diode across the input terminal to protect the unit against surge or spike voltage and input reverse voltage.

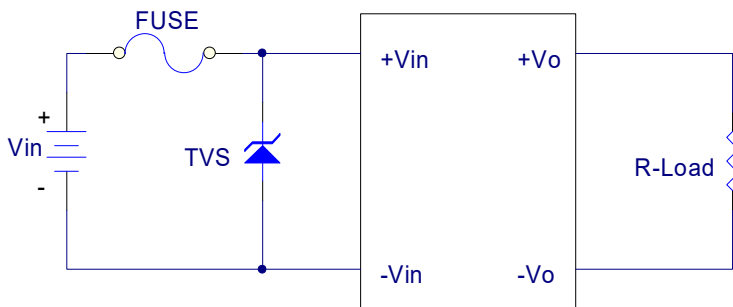
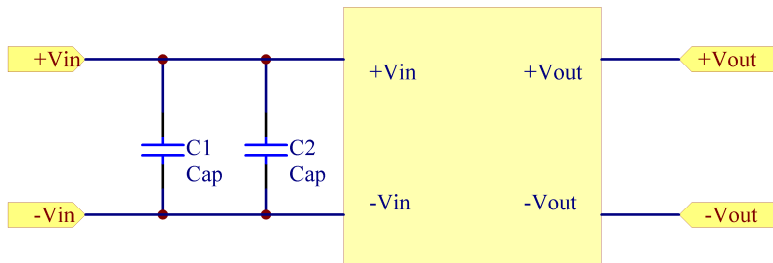

Figure10 Input Protection

#### 7.2 EMC Considerations

EMI Test standard: EN55022/EN55032 Class A Conducted Emission  
 Test Condition: Input Voltage: Nominal, Output Load: Full Load



Figur11 Connection circuit for conducted EMI testing

Model No.	EN55022 class A				
	C1	C2	Model No.	C1	C2
EC3SBW-24S33	6.8uF/50V	6.8uF/50V	EC3SBW-48S33	2.2uF/100V	2.2uF/100V
EC3SBW-24S05	6.8uF/50V	6.8uF/50V	EC3SBW-48S05	2.2uF/100V	2.2uF/100V
EC3SBW-24S12	6.8uF/50V	6.8uF/50V	EC3SBW-48S12	2.2uF/100V	2.2uF/100V
EC3SBW-24S15	6.8uF/50V	6.8uF/50V	EC3SBW-48S15	2.2uF/100V	2.2uF/100V
EC3SBW-24D05	6.8uF/50V	6.8uF/50V	EC3SBW-48D05	2.2uF/100V	2.2uF/100V
EC3SBW-24D12	6.8uF/50V	6.8uF/50V	EC3SBW-48D12	2.2uF/100V	2.2uF/100V
EC3SBW-24D15	6.8uF/50V	6.8uF/50V	EC3SBW-48D15	2.2uF/100V	2.2uF/100V

Note: All of capacitors are ceramic capacitors and 1812 size.



# EC3SBW 15W Isolated DC-DC Converters

## Application Note V14

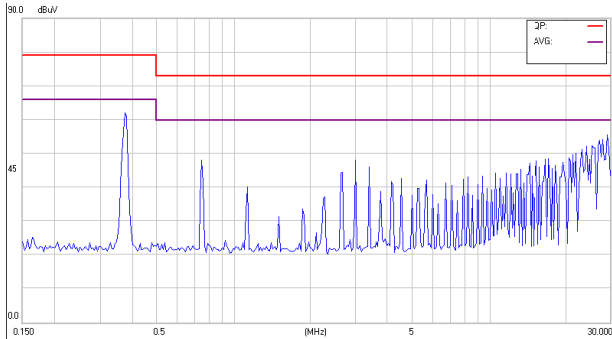

Figure 12 Conducted Class A of EC3SBW-24S33

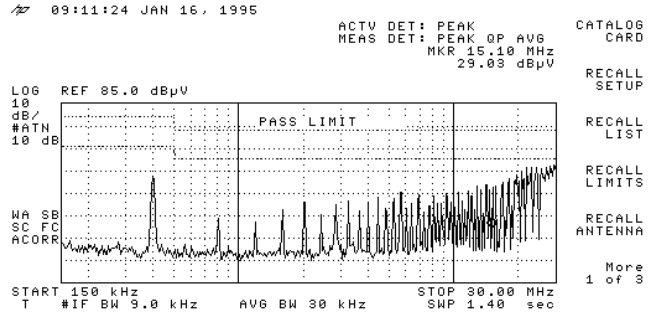

Figure 13 Conducted Class A of EC3SBW-24S05

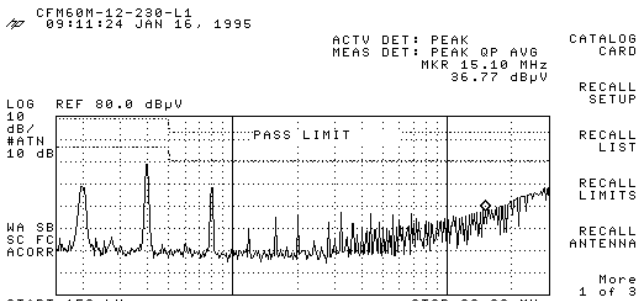

Figure 14 Conducted Class A of EC3SBW-24S12

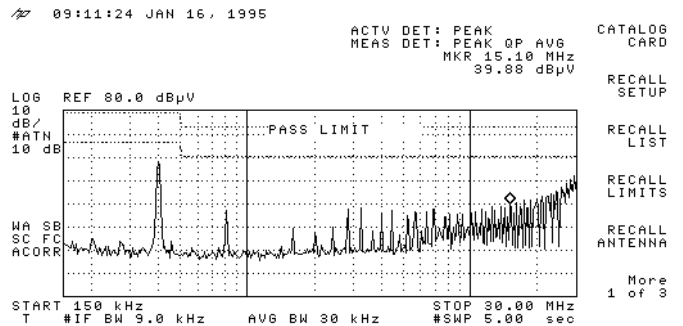

Figure 15 Conducted Class A of EC3SBW-24S15

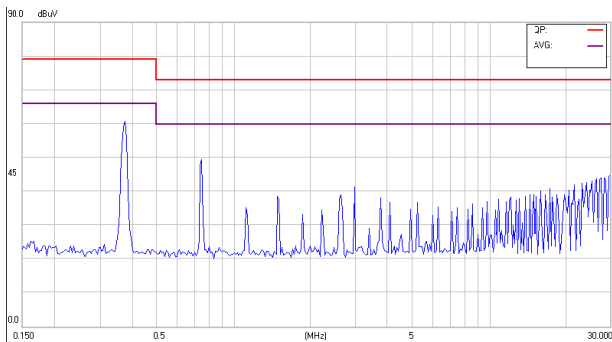

Figure 16 Conducted Class A of EC3SBW-24D05

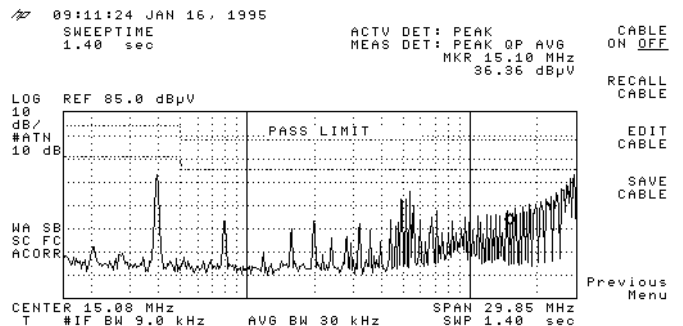

Figure 17 Conducted Class A of EC3SBW-24D12

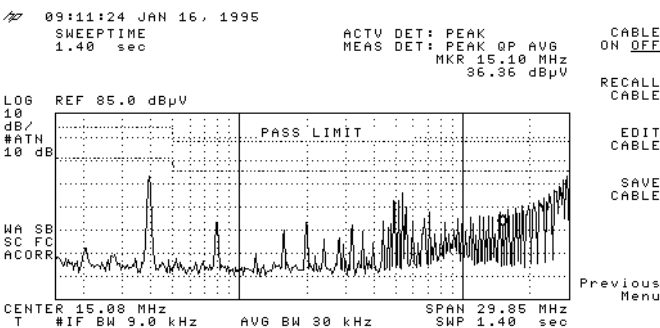

Figure 18 Conducted Class A of EC3SBW-24D15

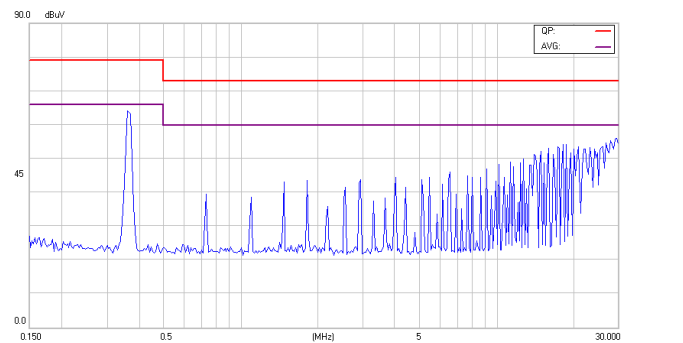

Figure 19 Conducted Class A of EC3SBW-48S33



# EC3SBW 15W Isolated DC-DC Converters

## Application Note V14

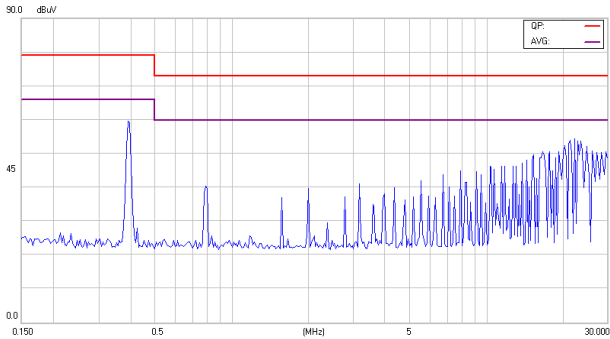

Figure20 Conducted Class A of EC3SBW-48S05

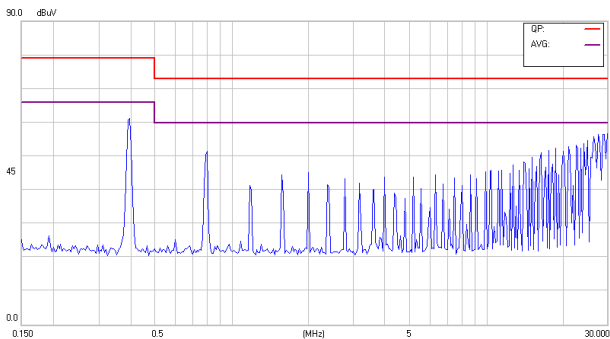

Figure22 Conducted Class A of EC3SBW-48S15

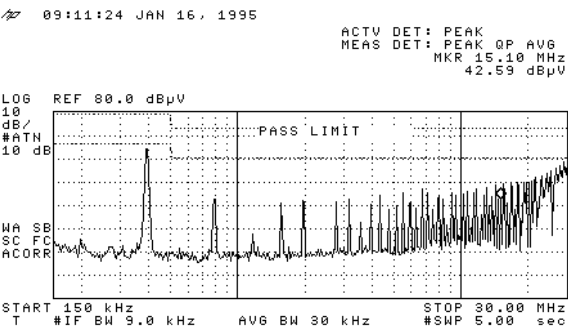

Figure24 Conducted Class A of EC3SBW-48D12

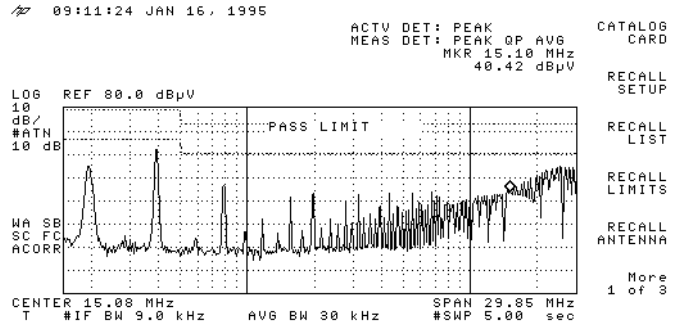

Figure21 Conducted Class A of EC3SBW-48S12

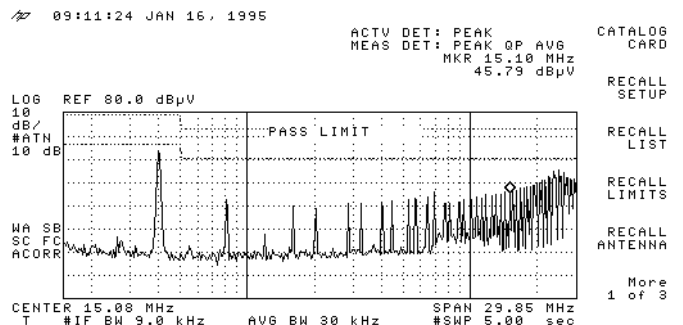

Figure23 Conducted Class A of EC3SBW-48D05

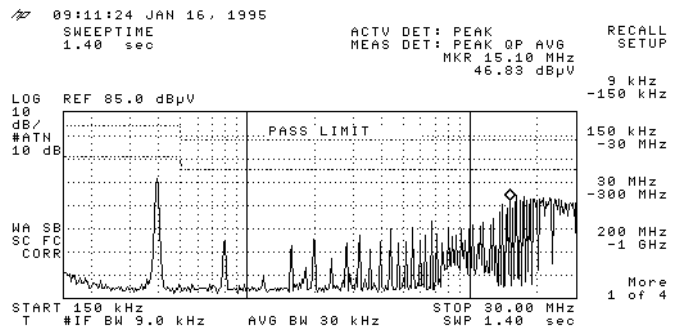

Figure25 Conducted Class A of EC3SBW-48D15



# EC3SBW 15W Isolated DC-DC Converters

## Application Note V14

### 8. Part Number

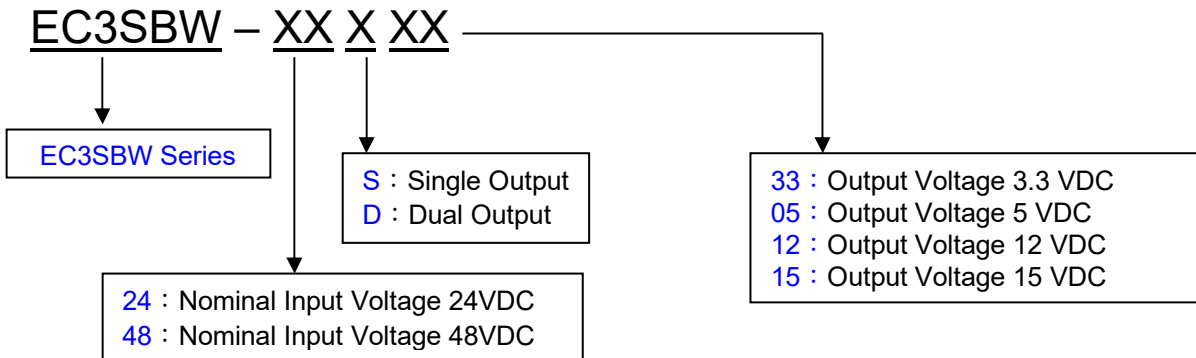

### 9. Mechanical Specifications

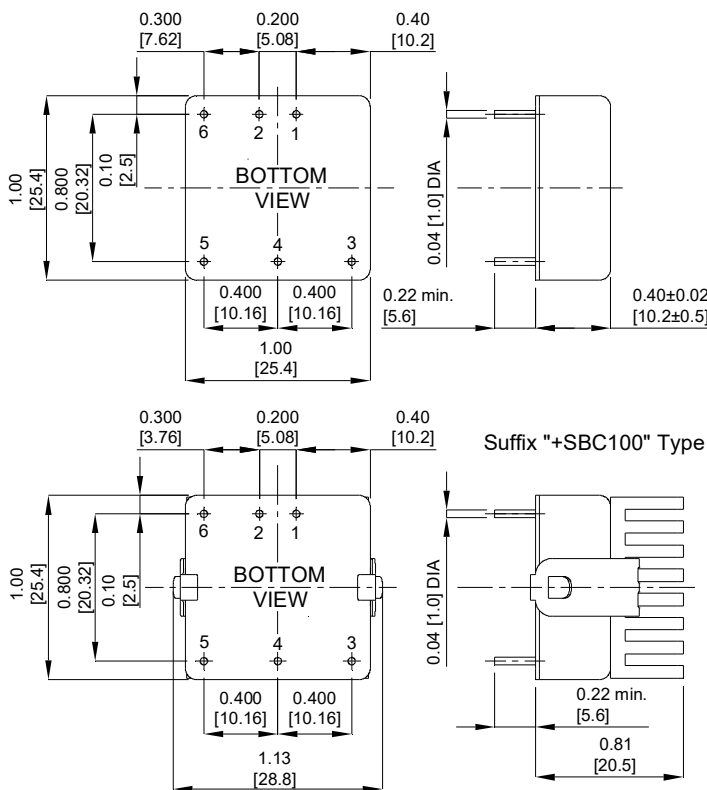

NOTE: Pin Size is 0.04±0.004 Inch [1.0±0.1 mm]DIA  
All Dimensions In Inches [mm]  
Tolerances Inches: X.XX= ±0.04 , X.XXX= ±0.010  
Millimeters: X.X= ±1.0 , X.XX=±0.25

PIN CONNECTION		
PIN	Single	Dual
1	+Input	+Input
2	-Input	-Input
3	+V Output	+V Output
4	Trim	Common
5	-V Output	-V Output
6	Remote	Remote

### CINCON ELECTRONICS CO., LTD.

#### Headquarters:

14F, No.306, Sec.4, Hsin Yi Rd.  
Taipei, Taiwan  
Tel: 886-2-27086210  
Fax: 886-2-27029852  
E-mail: [sales@cincon.com.tw](mailto:sales@cincon.com.tw)  
Web Site: <https://www.cincon.com>

#### Factory:

No. 8-1, Fu Kung Rd.  
Fu Hsing Industrial Park  
Fu Hsing Hsiang,  
ChangHua Hsien, Taiwan  
Tel: 886-4-7690261  
Fax: 886-4-7698031

#### Cincon North America:

1655Mesa Verde Ave. Ste 180  
Ventura, CA93003  
Tel: 805-639-3350  
Fax: 805-639-4101  
E-mail: [info@cincon.com](mailto:info@cincon.com)