



EC3SCW Series

Application Note V11 November 2020

**ISOLATED DC-DC CONVERTER
EC3SCW SERIES
APPLICATION NOTE**



Approved By:

Department	Approved By	Checked By	Written By
Research and Development Department	Enoch	Astray	Joyce
		Jacky	
Quality Assurance Department	Ryan	Benny	



EC3SCW Series

Application Note V11 November 2020

Content

1. INTRODUCTION	3
2. DC-DC CONVERTER FEATURES	3
3. ELECTRICAL BLOCK DIAGRAM	3
4. TECHNICAL SPECIFICATIONS	4
5. MAIN FEATURES AND FUNCTIONS	7
5.1 Operating Temperature Range	7
5.2 UVLO (Under Voltage Lock Out)	7
5.3 Over Voltage Protection	7
5.4 Over-Temperature Protection (OTP)	7
5.5 Output Voltage Adjustment	7
6. APPLICATIONS	7
6.1 Recommended Layout PCB Footprints and Soldering Information	7
6.2 Power De-Rating Curves for EC3SCW Series	8
6.3 Efficiency vs. Load Curves	9
6.4 Input Capacitance at the Power Module	11
6.5 Test Set-Up	11
6.6 Output Voltage Adjustment	11
6.7 Output Ripple and Noise Measurement	12
6.8 Output Capacitance	12
7. SAFETY & EMC	13
7.1 Input Fusing and Safety Considerations.	13
7.2 EMC Considerations	13
8. PART NUMBER	16
9. MECHANICAL SPECIFICATIONS	17



EC3SCW Series

Application Note V11 November 2020

1. Introduction

The EC3SCW series offer 30 watts of output power in a 2.00x1.60x0.4 inches copper packages. The EC3SCW series has a 4:1 wide input voltage range of 9-36 and 18-75VDC and provides a precisely regulated output. This series has features such as high efficiency, 1500VDC of isolation and allows an ambient operating temperature range of -40°C to 85°C (de-rating above 60°C). The modules are fully protected against input UVLO (under voltage lock out), output over-current, over-voltage and over-temperature and short circuit conditions. Furthermore, the standard control functions include remote on/off and adjustable output voltage. All models are very suitable for distributed power architectures, telecommunications, battery operated equipment and industrial applications.

2. DC-DC Converter Features

- 20-30W Isolated Output
- 2" X1.6" Six-Sided Shield Metal Case
- High Efficiency up to 91%
- Fixed 300KHz Switching Frequency
- 4:1 Wide Input Range
- Regulated Outputs
- Continuous Short Circuit Protection
- Industry Standard Pin-Out
- Safety Meets IEC/EN/UL 62368-1

3. Electrical Block Diagram

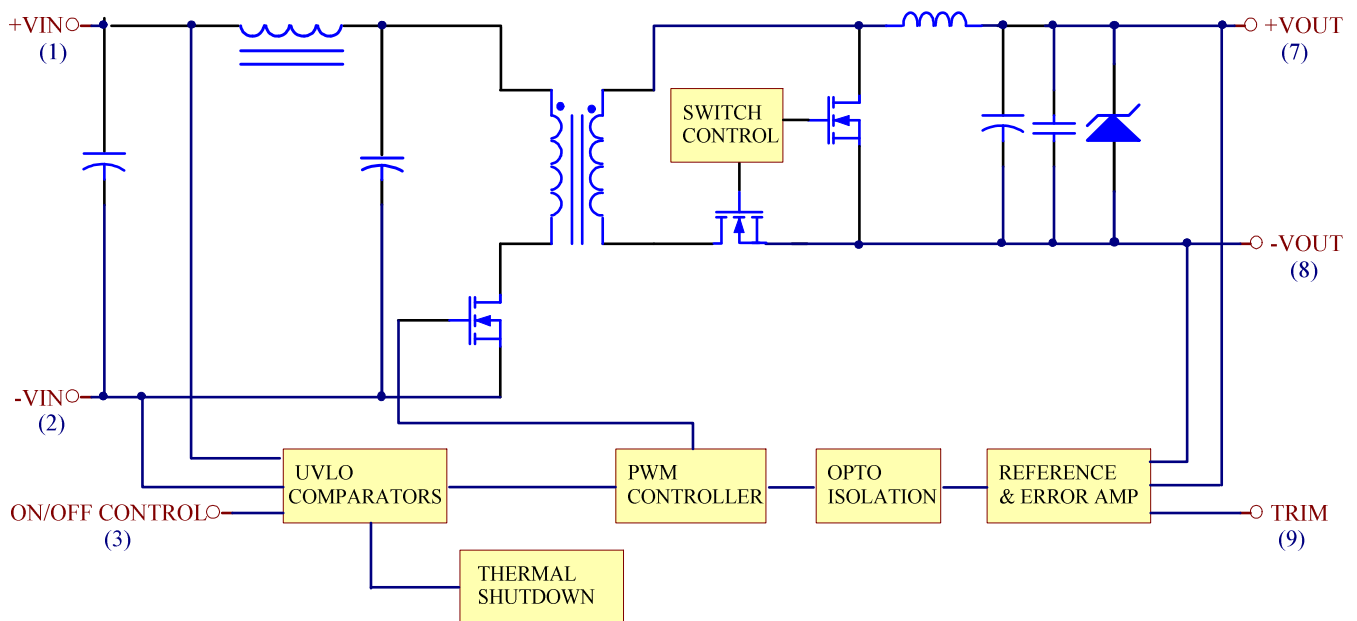

Figure 1 Electrical Block Diagram for Single Output Modules



EC3SCW Series

Application Note V11 November 2020

4. Technical Specifications

(All specifications are typical at nominal input, full load at 25°C unless otherwise noted.)

ABSOLUTE MAXIMUM RATINGS

PARAMETER	NOTES and CONDITIONS	Device	Min.	Typical	Max.	Units
Input Voltage						
Continuous		24Vin 48Vin	9 18	24 48	36 75	Vdc
Transient	100ms	24Vin 48Vin			50 100	Vdc
Operating Ambient Temperature	Derating, above 60°C	All	-40		+85	°C
Case Temperature		All			100	°C
Storage Temperature		All	-55		+125	°C
Input/Output Isolation Voltage	1 minute	All			1500	Vdc

INPUT CHARACTERISTICS

PARAMETER	NOTES and CONDITIONS	Device	Min.	Typical	Max.	Units
Operating Input Voltage		24Vin 48Vin	9 18	24 48	36 75	Vdc
Input Under Voltage Lockout						
Turn-On Voltage Threshold		24Vin 48Vin	8 16.5	8.5 17	8.8 17.5	V _{dc}
Turn-Off Voltage Threshold		24Vin 48Vin	7.7 15.5	8 16	8.3 16.5	V _{dc}
Lockout Hysteresis Voltage		24Vin 48Vin		0.6 0.9		V _{dc}
Maximum Input Current	100% Load, Vin=9V	24Vin		3850		mA
	100% Load, Vin=18V	48Vin		1900		
No-Load Input Current	Vin=24V	24S33		50		mA
		24S05		60		
		24S12		80		
		24S15		50		
No-Load Input Current	Vin=48V	48S33		30		mA
		48S05		30		
		48S12		40		
		48S15		50		
Inrush Current (I ² t)	As per ETS300 132-2	All			0.1	A ² s
Input Reflected-Ripple Current	P-P thru 12uH inductor, 5Hz to 20MHz	All			30	mA

OUTPUT CHARACTERISTIC

PARAMETER	NOTES and CONDITIONS	Device	Min.	Typical	Max.	Units
Output Voltage Set Point	Vin=nominal input, Io= Io _{max} .	Vo=3.3	3.2505	3.3	3.3495	Vdc
		Vo=5.0	4.925	5	5.075	
		Vo=12	11.82	12	12.18	
		Vo=15	14.775	15	15.225	



EC3SCW Series

Application Note V11 November 2020

PARAMETER	NOTES and CONDITIONS	Device	Min.	Typical	Max.	Units
Output Voltage Regulation						
Load Regulation	Io=full load to min. Load	Single			±0.5	%
Line Regulation	Vin=high line to low line, full Load	Single			±0.5	%
Temperature Coefficient	TC=-40°C to 85°C				±0.02	%/°C
Output Voltage Ripple and Noise						
5Hz to 20MHz Bandwidth						
Peak-to-Peak	Full Load, 0.1uF ceramic capacitor.	Vo=3.3V			75	mV
		Vo=5V				
		Vo=12V			100	
		Vo=15V				
Operating Output Current Range		Vo=3.3V	0		7500	mA
		Vo=5V	0		6000	
		Vo=12V	0		2500	
		Vo=15V	0		2000	
Output DC Current-Limit Inception	Vo=90% Vo, nominal	All	110	130	150	%
Maximum Output Capacitance	Full load (resistive)	Vo=3.3V			7500	uF
		Vo=5V			6000	
		Vo=12V			2500	
		Vo=15V			2000	

DYNAMIC CHARACTERISTICS

PARAMETER	NOTES and CONDITIONS	Device	Min.	Typical	Max.	Units
Output Voltage Current Transient						
Step Change in Output Current	75% to 100% of Io,max.	All			±5	%
Setting Time (within 1% Vo nominal)	di/dt=0.1A/us	All			300	us
Turn-On Delay and Rise Time						
Turn-On Delay Time, From On/Off Control	Von/off to 10%Vo, set	All		1		ms
Turn-On Delay Time, From Input	Vin, min. to 10%Vo, set	All		3		ms
Output Voltage Rise Time	10%Vo, set to 90%Vo, set	All		5		ms

EFFICIENCY

PARAMETER	NOTES and CONDITIONS	Device	Min.	Typical	Max.	Units
100% Load	Vin=24V	24S33		88		%
		24S05		89		
		24S12		91		
		24S15		91		
	Vin=48V	48S33		88		
		48S05		90		
		48S12		91		
		48S15		91		



EC3SCW Series

Application Note V11 November 2020

ISOLATION CHARACTERISTICS

PARAMETER	NOTES and CONDITIONS	Device	Min.	Typical	Max.	Units
Input to Output	1 minutes	All			1500	Vdc
Isolation Resistance		All	100			MΩ
Isolation Capacitance		All		1000		pF

FEATURE CHARACTERISTICS

PARAMETER	NOTES and CONDITIONS	Device	Min.	Typical	Max.	Units
Switching Frequency	Vin=24V	24Vin		300		KHz
	Vin=48V	48Vin		250		KHz
On/Off Control, Positive Remote On/Off logic						
Logic Low (Module Off)	Von/off at Ion/off=1.0mA	All	0		1.2	V
Logic High (Module On)	Von/off at Ion/off=0.1uA	All	3.5 or Open Circuit		75	V
On/Off Current (for both remote on/off logic)	Ion/off at Von/off=0.0V	All		0.3	1	mA
Leakage Current (for both remote on/off logic)	Logic high, Von/off=15V	All			30	uA
Off Converter Input Current	Shutdown input idle current	All		4	10	mA
Output Voltage Trim Range	Pout=maximum rated power	All	-10		+10	%
Output Over Voltage Protection	Zener or TVS clamp	Vo=3.3V Vo=5.0V Vo=12V Vo=15V		3.9 6.2 15 18		Vdc
Over-Temperature Shutdown		All		110		°C

GENERAL SPECIFICATIONS

PARAMETER	NOTES and CONDITIONS	Device	Min.	Typical	Max.	Units
MTBF	Io=100%of Io.max. Ta=25°C per MIL-HDBK-217F	All		650		K hours
Weight		All		50		grams



EC3SCW Series

Application Note V11 November 2020

5. Main Features and Functions

5.1 Operating Temperature Range

The EC3SCW series converters can be operated by a wide ambient temperature range from -40°C to 85°C (de-c above 60°C). The standard model has a copper case and case temperature can not over 100°C at normal operating.

5.2 UVLO (Under Voltage Lock Out)

Input under voltage lockout is standard on the EC3SCW unit. The unit will shut down when the input voltage drops below a threshold, and the unit will operate when the input voltage goes above the upper threshold.

5.3 Over Voltage Protection

The over-voltage protection consists of a zener diode to limiting the out voltage.

5.4 Over-Temperature Protection (OTP)

The EC3SCW series converters are equipped with non-latching over-temperature protection. If the temperature exceeds a threshold of 110°C (typical) the converter will shut down, disabling the output. When the temperature has decreased the converter will automatically restart. The over-temperature condition can be induced by a variety of reasons such as external overload condition or a system fan failure.

5.5 Output Voltage Adjustment

Section 6.6 describes in detail how to trim the output voltage with respect to its set point. The output voltage on all models is adjustable within the range of $+10\%$ to -10% . (Single output models only)

6. Applications

6.1 Recommended Layout PCB Footprints and Soldering Information

The system designer or the end user must ensure that other components and metal in the vicinity of the converter meet the spacing requirements to which the system is approved. Low resistance and low inductance PCB layout traces are the norm and should be used where possible. Due consideration must also be given to proper low impedance tracks between power module, input and output grounds. The

recommended footprints and soldering profiles are shown as Figure 2.

All Dimensions In Inches(mm)
 Tolerances Inches: X.XX= ± 0.04 , X.XXX= ± 0.010
 Millimeters: X.X= ± 1.0 , X.XX= ± 0.25

1.3mm PLATED THROUGH HOLE
 2.0mm PAD SIZE

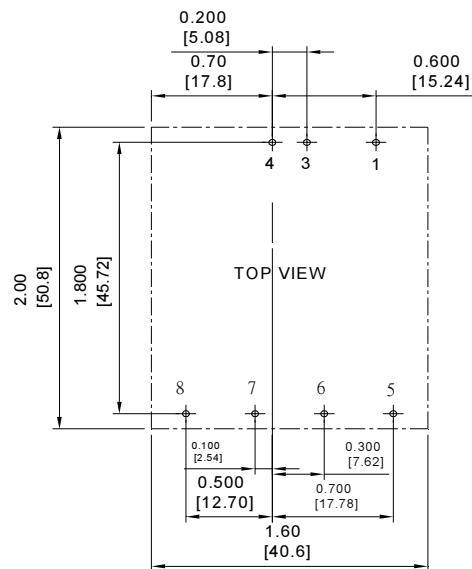

Lead Free Wave Soldering Profile

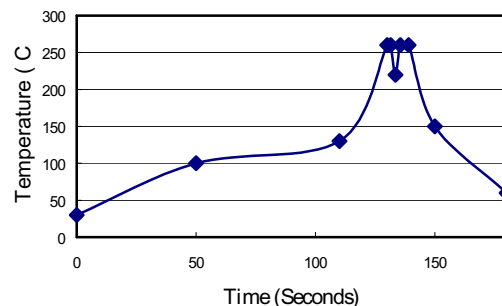

Figure2

Recommended PCB Layout Footprint and Soldering Profile

Note :

1. Soldering Materials: Sn/Cu/Ni
2. Ramp up rate during preheat: $1.4^{\circ}\text{C}/\text{Sec}$ (From 50°C to 100°C)
3. Soaking temperature: $0.5^{\circ}\text{C}/\text{Sec}$ (From 100°C to 130°C), 60 ± 20 seconds
4. Peak temperature: 260°C , above 250°C 3~6 Seconds
5. Ramp up rate during cooling: $-10.0^{\circ}\text{C}/\text{Sec}$ (From 260°C to 150°C)



EC3SCW Series

Application Note V11 November 2020

6.2 Power De-Rating Curves for EC3SCW Series

Operating Ambient temperature Range: $-40^{\circ}\text{C} \sim 85^{\circ}\text{C}$ (derating above 60°C). Maximum case temperature under any operating condition should not exceed 100°C .

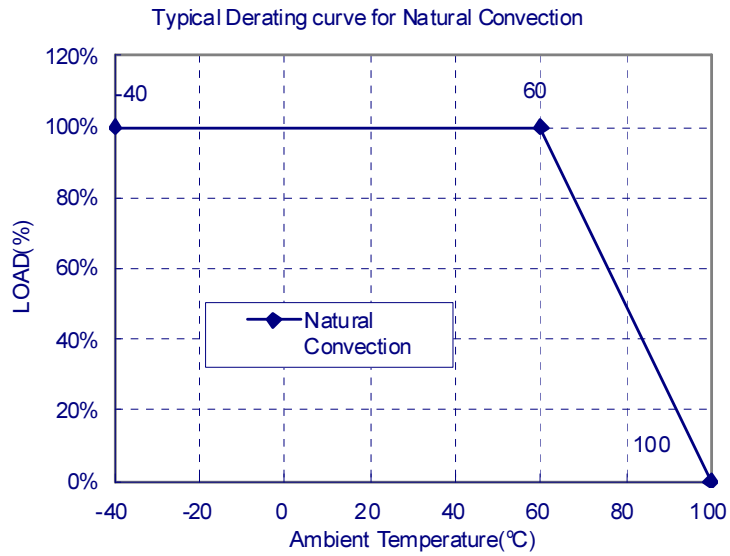

Figure3 Typical Power De-Rating Curve for EC3SCW Series



EC3SCW Series

Application Note V11 November 2020

6.3 Efficiency vs. Load Curves

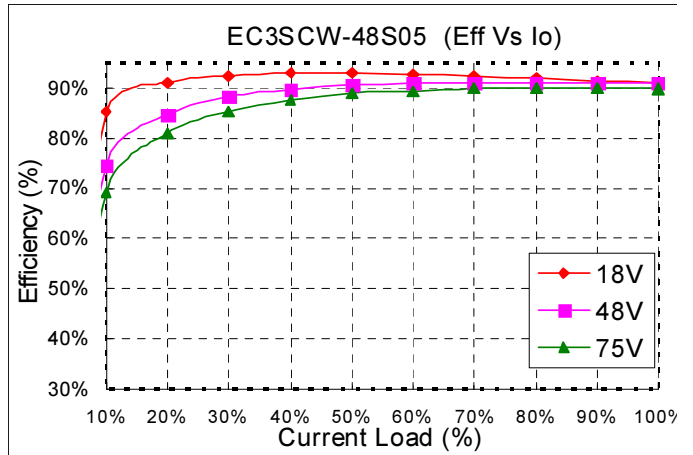
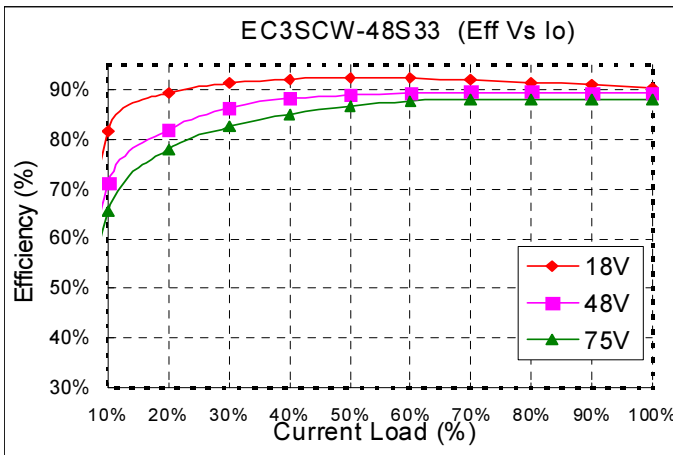
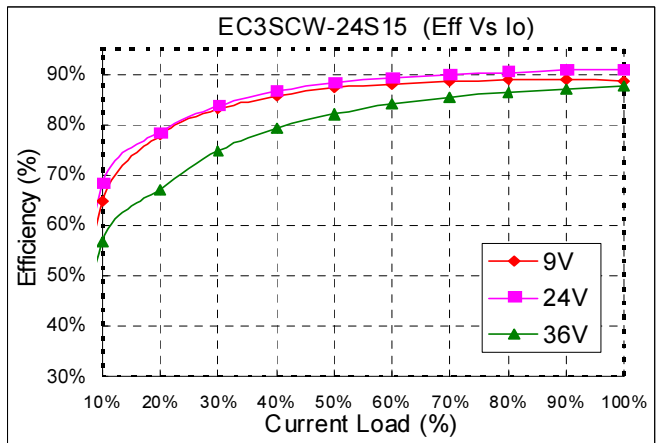
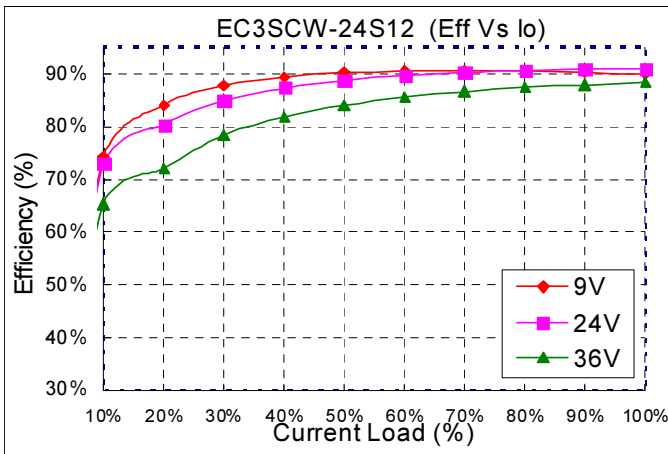
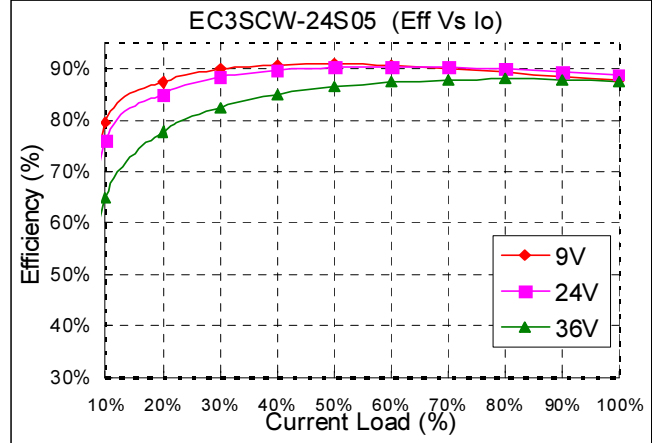
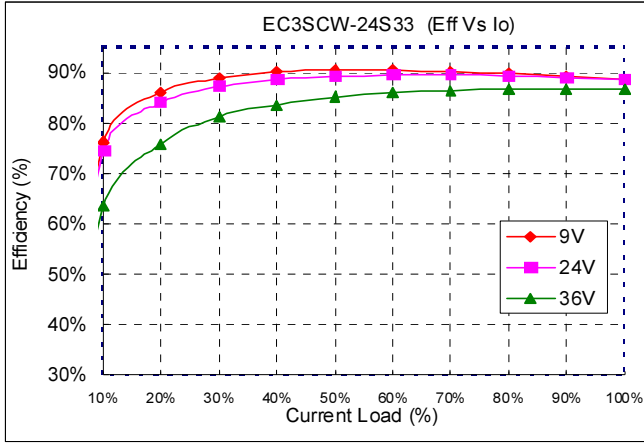



EC3SCW Series

Application Note V11 November 2020

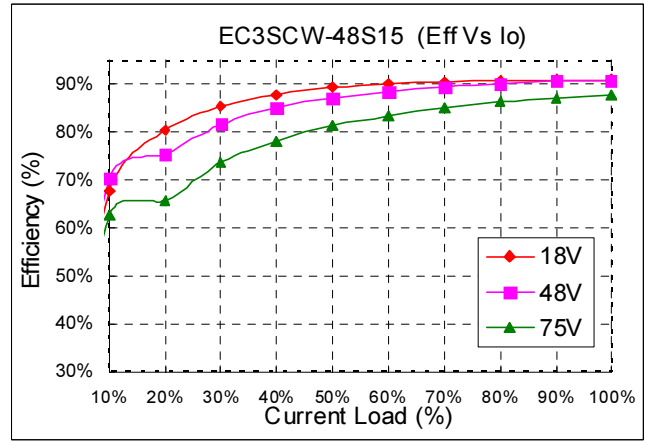
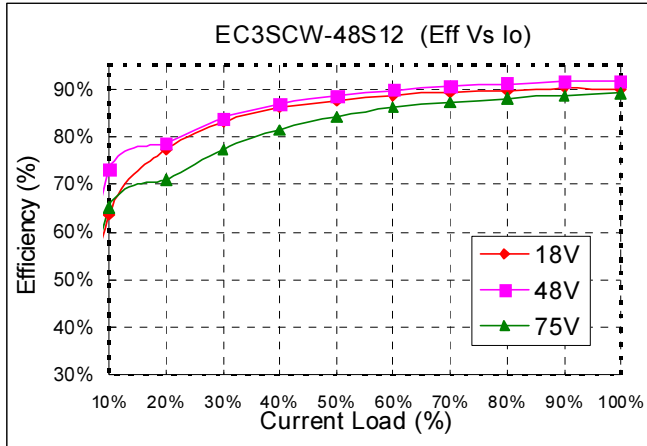



EC3SCW Series

Application Note V11 November 2020

6.4 Input Capacitance at the Power Module

The converters must be connected to low AC source impedance. To avoid problems with loop stability source inductance should be low. Also, the input capacitors (Cin) should be placed close to the converter input pins to de-couple distribution inductance. However, the external input capacitors are chosen for suitable ripple handling capability. Low ESR capacitors are good choice. Circuit as shown in Figure 4 represents typical measurement methods for reflected ripple current. C1 and L1 simulate a typical DC source impedance. The input reflected-ripple current is measured by current probe to oscilloscope with a simulated.

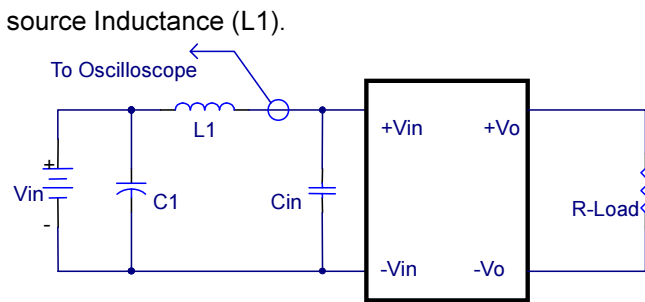

L1: 12uH
 C1: 220uF ESR <0.1ohm @100KHz.
 Cin: 33uF ESR<0.7ohm @100KHz

Figure 4 Input Reflected-Ripple Test Setup

6.5 Test Set-Up

The basic test set-up to measure parameters such as efficiency and load regulation is shown in Figure 5. When testing the modules under any transient conditions please ensure that the transient response of the source is sufficient to power the equipment under test. We can calculate the

- Efficiency
- Load regulation and line regulation.

The value of efficiency is defined as:

$$\eta = \frac{V_O \times I_O}{V_{IN} \times I_{IN}} \times 100\%$$

Where

- Vo is output voltage,
- Io is output current,
- Vin is input voltage,
- Iin is input current.

The value of load regulation is defined as:

$$Load.reg = \frac{V_{FL} - V_{NL}}{V_{NL}} \times 100\%$$

Where

- V_{FL} is the output voltage at full load
- V_{NL} is the output voltage at 10% load

The value of line regulation is defined as:

$$Line.reg = \frac{V_{HL} - V_{LL}}{V_{LL}} \times 100\%$$

Where

- V_{HL} is the output voltage of maximum input voltage at full load.
- V_{LL} is the output voltage of minimum input voltage at full load.

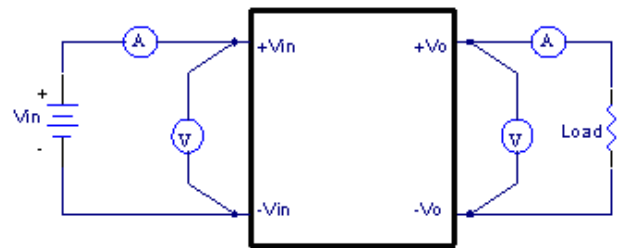

Figure 5 EC3SCW Series Test Setup

6.6 Output Voltage Adjustment

In order to trim the voltage up or down one needs to connect the trim resistor either between the trim pin and -Vo for trim-up and between trim pin and +Vo for trim-down. The output voltage trim range is ±10%. (Single output models only) This is shown in Figure 6 and 7:

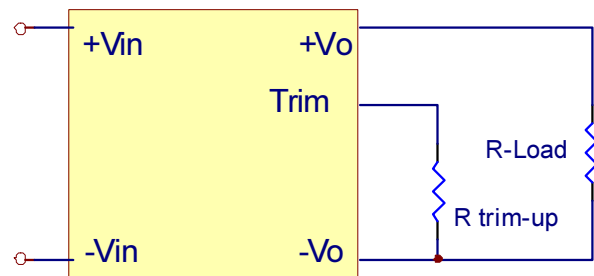

Figure 6 Trim-up Voltage Setup

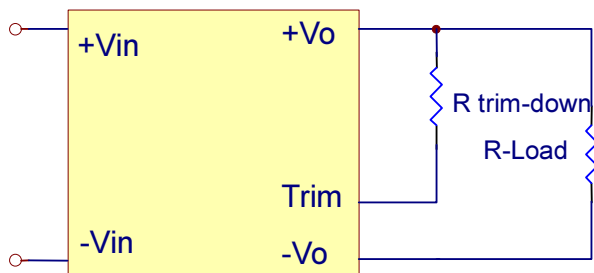

Figure 7 Trim-down Voltage Setup

F



EC3SCW Series

Application Note V11 November 2020

1. The value of $R_{trim-up}$ defined as:

$$R_{trim-up} = \left(\frac{V_r \times R1 \times (R2 + R3)}{(V_o - V_{o,nom}) \times R2} \right) - R_t \text{ (K}\Omega\text{)}$$

Where

$R_{trim-up}$ is the external resistor in Kohm.
 $V_{o,nom}$ is the nominal output voltage.
 V_o is the desired output voltage.
 $R1, R_t, R2, R3$ and V_r are internal to the unit and are defined in Table 1.

Table 1 – Trim up and Trim down Resistor Values

Model Number	Output Voltage(V)	R1 (KΩ)	R2 (KΩ)	R3 (KΩ)	Rt (KΩ)	Vr (V)
EC3SCW24S33 EC3SCW48S33	3.3	2.74	1.8	0.27	9.1	1.24
EC3SCW24S05 EC3SCW48S05	5.0	2.32	2.32	0	8.2	2.5
EC3SCW24S12 EC3SCW48S12	12.0	6.8	2.4	2.32	22	2.5
EC3SCW24S15 EC3SCW48S15	15.0	8.06	2.4	3.9	27	2.5

For example, to trim-up the output voltage of 5V module (EC3SCW-24S05) by 10% to 5.5V, $R_{trim-up}$ is calculated as follows:

$$\begin{aligned} V_o - V_{o,nom} &= 5.5 - 5 = 0.5V \\ R1 &= 2.32 \text{ K}\Omega \\ R2 &= 2.32 \text{ K}\Omega \\ R3 &= 0 \text{ K}\Omega \\ R_t &= 8.2 \text{ K}\Omega, \\ V_r &= 2.5 \text{ V} \end{aligned}$$

$$R_{trim-up} = \left(\frac{2.5 \times 2.32 \times (2.32 + 0)}{0.5 \times 2.32} \right) - 8.2 = 3.4 \text{ (K}\Omega\text{)}$$

2. The value of $R_{trim-down}$ defined as:

$$R_{trim-down} = R1 \times \left(\frac{V_r \times R1}{(V_{o,nom} - V_o) \times R2} - 1 \right) - R_t \text{ (K}\Omega\text{)}$$

Where

$R_{trim-down}$ is the external resistor in Kohm.
 $V_{o,nom}$ is the nominal output voltage.
 V_o is the desired output voltage.
 $R1, R_t, R2, R3$ and V_r are internal to the unit and are defined in Table 1

For example, to trim-down the output voltage of 5.0V module (EC3SCW-24S05) by 10% to 4.5V, $R_{trim-down}$ is calculated as follows:

$$\begin{aligned} V_{o,nom} - V_o &= 5.0 - 4.5 = 0.5V \\ R1 &= 2.32 \text{ K}\Omega \\ R2 &= 2.32 \text{ K}\Omega \\ R3 &= 0 \text{ K}\Omega \\ R_t &= 8.2 \text{ K}\Omega \\ V_r &= 2.5 \text{ V} \end{aligned}$$

$$R_{trim-down} = 2.32 \times \left(\frac{(2.5 \times 2.32)}{0.5 \times 2.32} - 1 \right) - 8.2 = 1.08 \text{ (K}\Omega\text{)}$$

6.7 Output Ripple and Noise Measurement

The test set-up for noise and ripple measurements is shown in Figure 8. A coaxial cable was used to prevent impedance mismatch reflections disturbing the noise readings at higher frequencies. Measurements are taken with output appropriately loaded and all ripple/noise specifications are from 5Hz to 20MHz bandwidth.

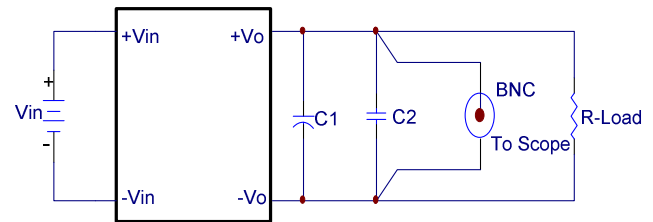

Note: C1: none

C2: 0.1uF ceramic capacitor

Figure 8 Output Voltage Ripple and Noise Measurement Set-Up

6.8 Output Capacitance

The EC3SCW series converters provide unconditional stability with or without external capacitors. For good transient response low ESR output capacitors should be located close to the point of load. These series converters are designed to work with load capacitance to see technical specifications.



EC3SCW Series

Application Note V11 November 2020

7. Safety & EMC

7.1 Input Fusing and Safety Considerations.

The EC3SCW series converters have not an internal fuse. However, to achieve maximum safety and system protection, always use an input line fuse. We recommended a time delay fuse 6A for 24Vin models and 3A for 48Vin modules. Figure 9 circuit is recommended by a Transient Voltage Suppressor diode across the input terminal to protect the unit against surge or spike voltage and input reverse voltage.

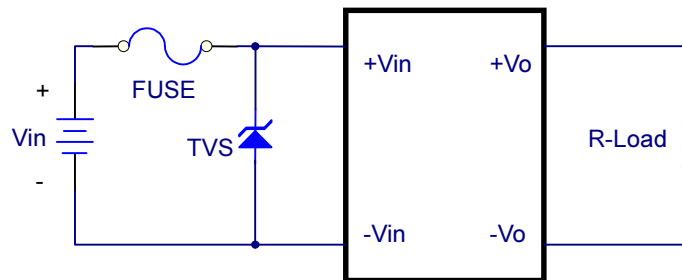

Figure 9 Input Protection

7.2 EMC Considerations

EMI Test standard: EN55022 Class A or Class B Conducted Emission

Test Condition: Nominal Input, Full Load at 25°C

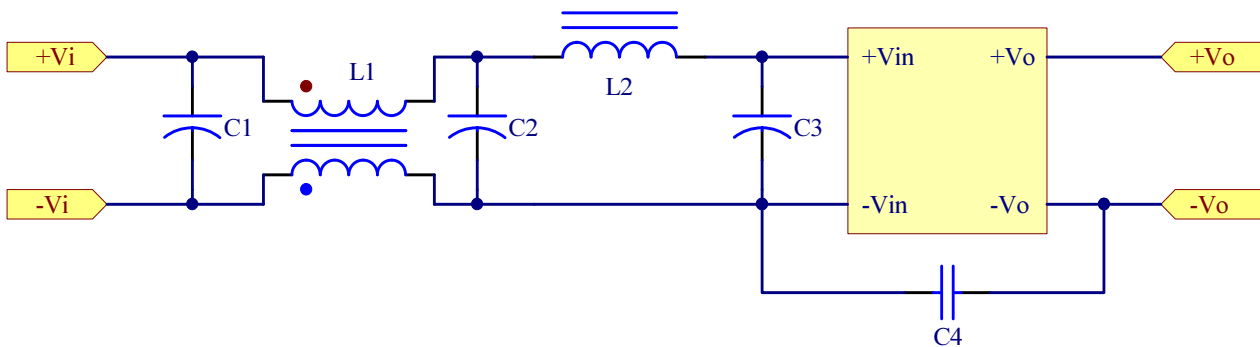

Figure 10 Connection circuit for conducted EMI testing



EC3SCW Series

Application Note V11 November 2020

EN55022 Class A							EN55022 Class B					
Model No.	C1	C2	C3	C4	L1	L2	C1	C2	C3	C4	L1	L2
EC3SCW-24S33	NC	10uF/5 0V KY	22uF/5 0V KY	NC	Short	3.4 uH	NC	100uF/ 100V PW	100uF/ 100V PW	2200pF	0.65mH	3.4uH
EC3SCW-24S05												
EC3SCW-24S12												
EC3SCW-24S15												
EC3SCW-48S33	NC	NC	220uF/ 100V KMF	NC	Short	Short	NC	100uF/ 100V PW	100uF/ 100V PW	2200pF	0.65mH	3.4uH
EC3SCW-48S05												
EC3SCW-48S12												
EC3SCW-48S15												

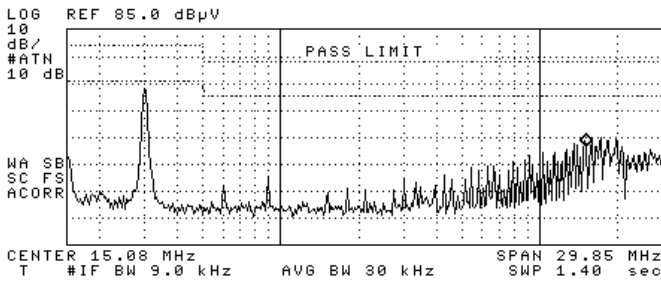

Figure 11 Conducted Class A of EC3SCW-24S33

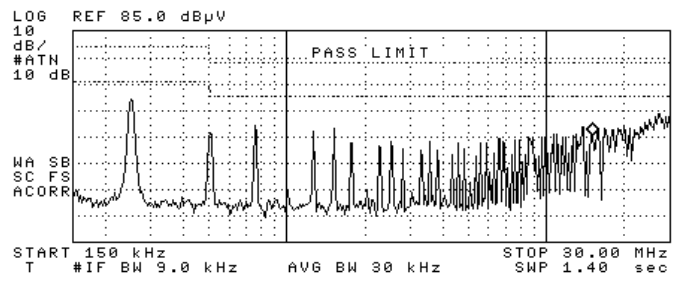

Figure 15 Conducted Class A of EC3SCW-48S33

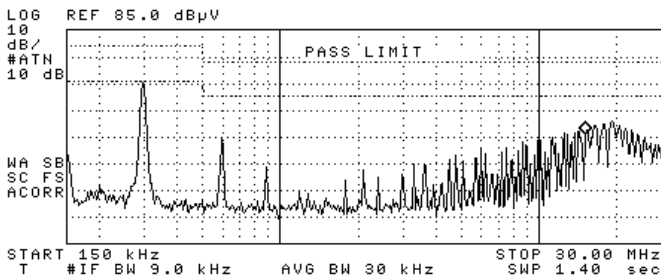

Figure 12 Conducted Class A of EC3SCW-24S05

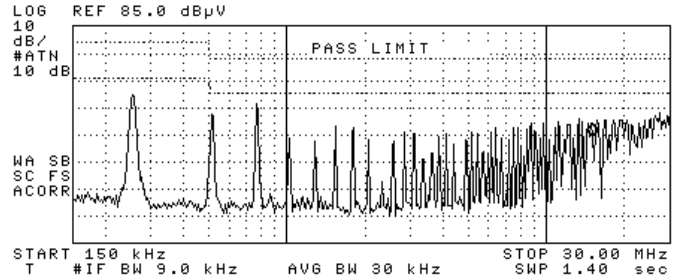

Figure 16 Conducted Class A of EC3SCW-48S05

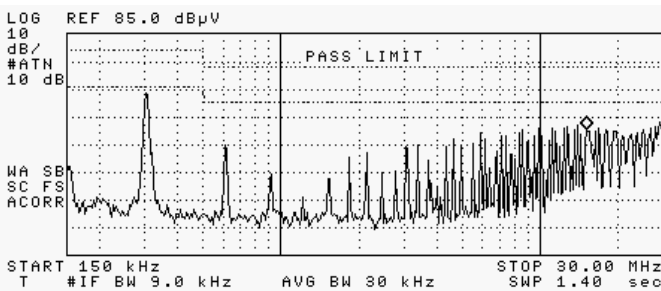

Figure 13 Conducted Class A of EC3SCW-24S12

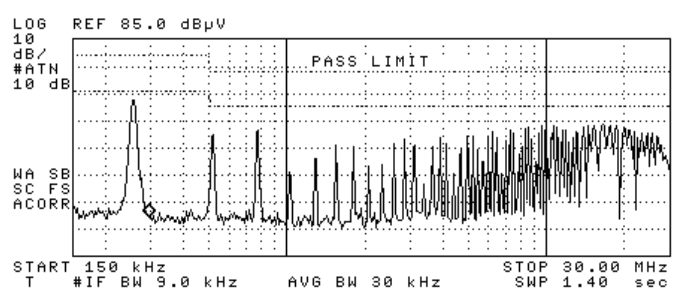

Figure 17 Conducted Class A of EC3SCW-48S12



EC3SCW Series

Application Note V11 November 2020

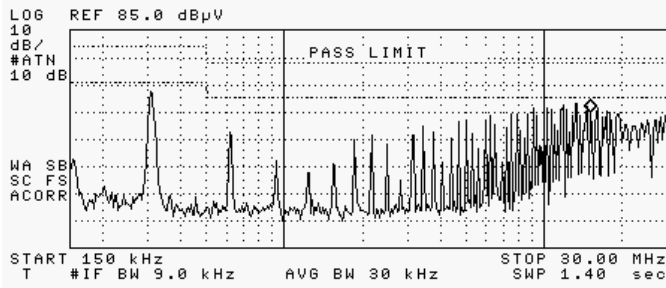

Figure 14 Conducted Class A EC3SCW-24S15

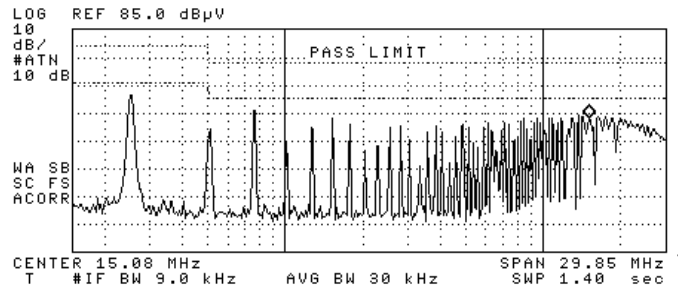

Figure 18 Conducted Class A of EC3SCW-48S15

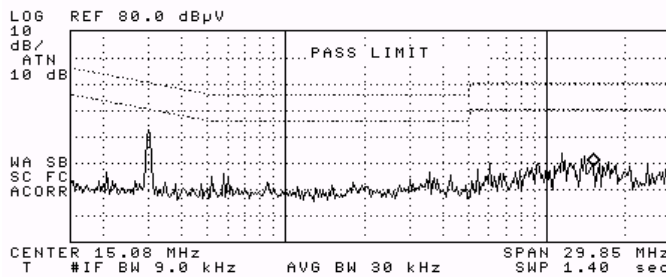

Figure 19 Conducted Class B of EC3SCW-24S33

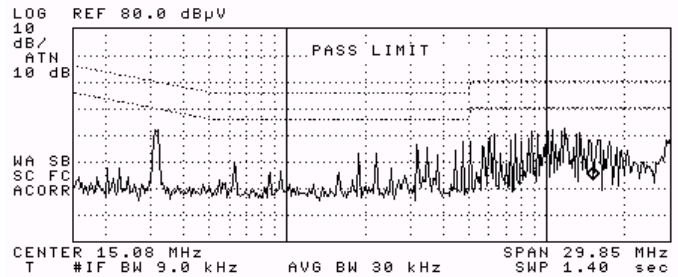

Figure 22 Conducted Class B of EC3SCW-24S15

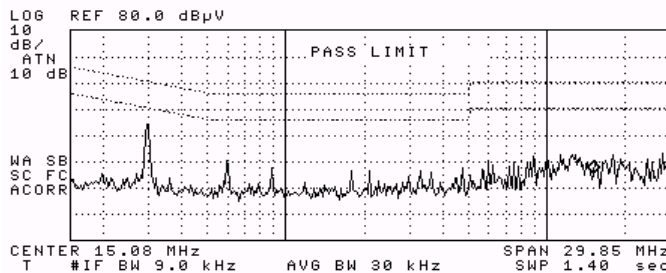

Figure 20 Conducted Class B of EC3SCW-24S05

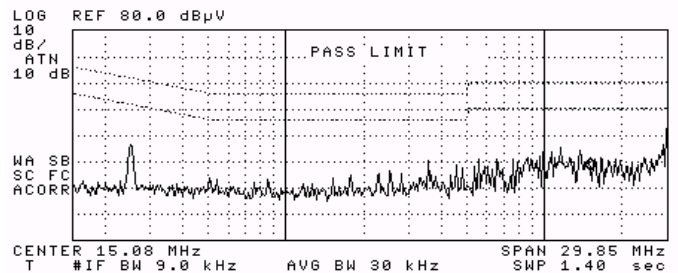

Figure 23 Conducted Class B of EC3SCW-48S33

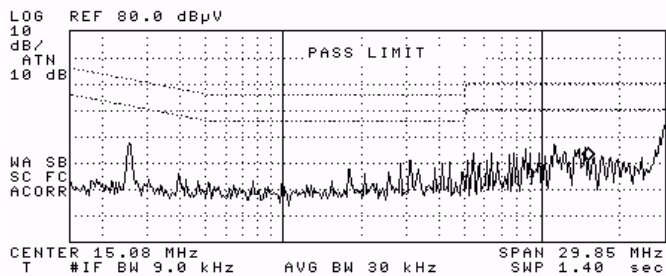

Figure 21 Conducted Class B of EC3SCW-24S12

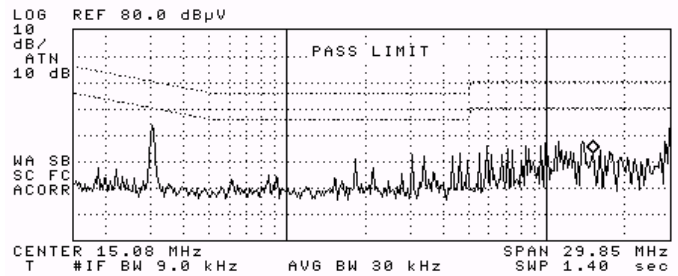

Figure 24 Conducted Class B of EC3SCW-48S05



EC3SCW Series

Application Note V11 November 2020

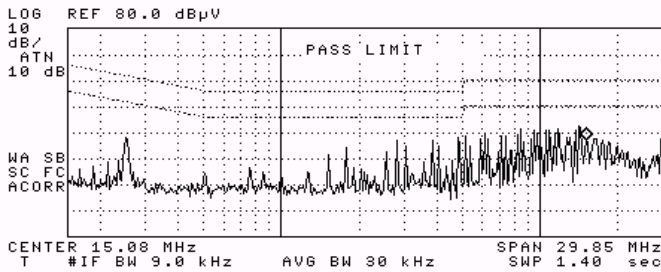

Figure 25 Conducted Class B of EC3SCW-48S12

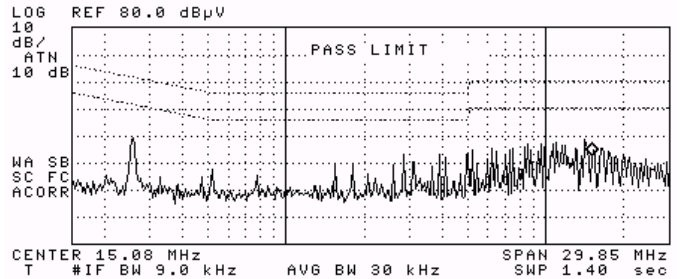
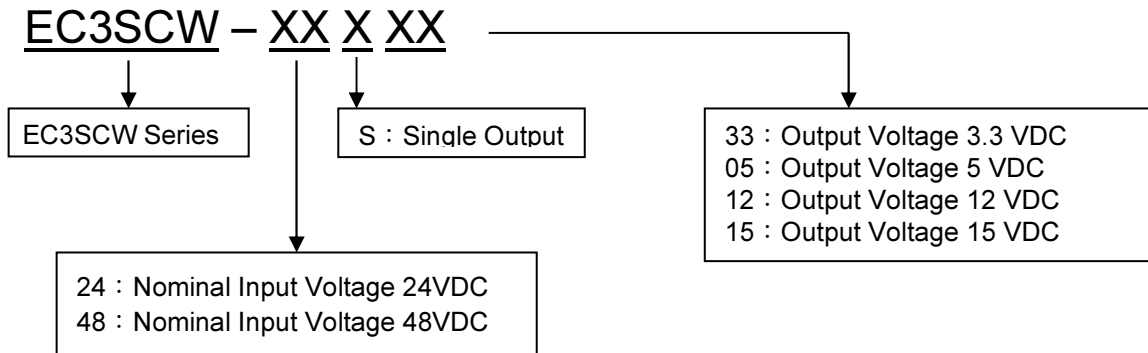

Figure 26 Conducted Class B of EC3SCW-48S15

8. Part Number





EC3SCW Series

Application Note V11 November 2020

9. Mechanical Specifications

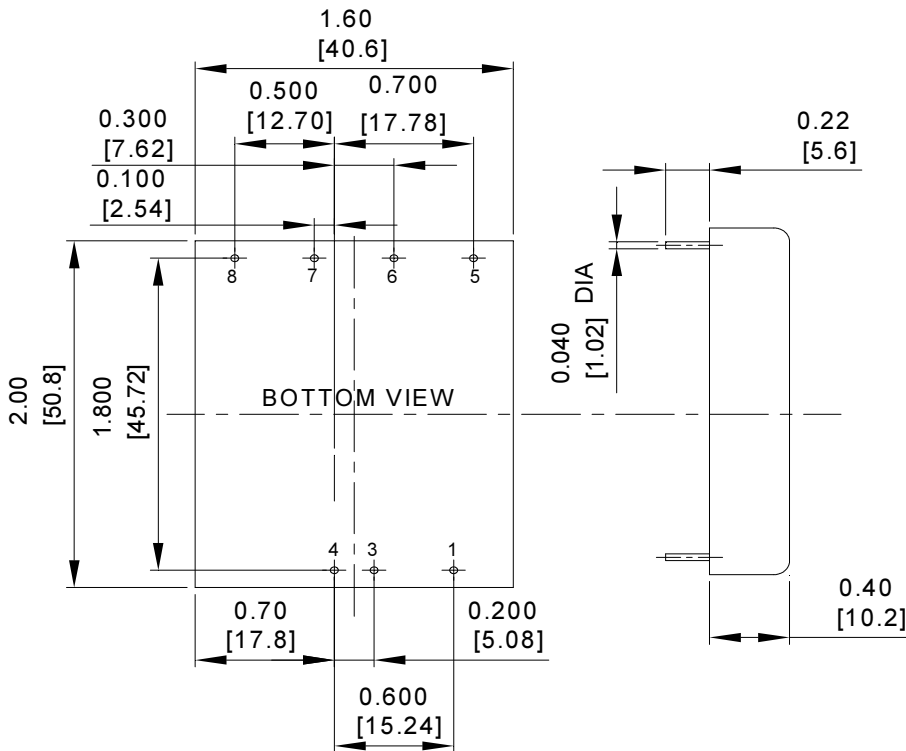

PIN CONNECTIONS	
Pin	Function
1	On/Off Control
3	-V Input
4	+V Input
5	Trim
6	-V Output
7	+V Output
8	No Pin

NOTE: Pin Size is 0.04±0.004 Inch (1.0±0.1mm)DIA
 All Dimensions In Inches(mm)
 Tolerances Inches: X.XX= ±0.04 , X.XXX= ±0.010
 Millimeters: X.X= ±1.0 , X.XX=±0.25

CINCON ELECTRONICS CO., LTD.

Headquarter Office:

14F, No.306, Sec.4, Hsin Yi Rd.,
 Taipei, Taiwan
 Tel: 886-2-27086210
 Fax: 886-2-27029852
 E-mail: sales@cincon.com.tw
 Web Site: <http://www.cincon.com>

Factory:

No. 8-1, Fu Kong Rd.,
 Fu Hsing Industrial Park
 Fu Hsing Hsiang, ChangHua Hsien,
 Taiwan
 Tel: 886-4-7690261
 Fax: 886-4-7698031

Cincon American Office:

1655 Mesa Verde Ave, Ste 180,
 Ventura, CA 93003
 Tel: 805-639-3350
 Fax: 805-639-4101
 E-mail: info@cincon.com