



# EC4SAWH Series Application Note V10

## ISOLATED DC-DC CONVERTER EC4SAWH SERIES APPLICATION NOTE



### Approved By:

Department	Approved By	Checked By	Written By
Research and Development Department	Enoch	Danny	Eunice
		Jacky	
Quality Assurance Department	Ryan	Benny	



# EC4SAWH Series Application Note V10

---

## Contents

1. Introduction .....	3
2. Pin Function Description .....	3
3. Connection for Standard Use .....	4
4. Test Set-Up .....	4
5. Recommend Layout, PCB Footprint and Soldering Information .....	4
6. Features and Functions .....	5
6.1 Over Current/Short Circuit Protection .....	5
6.2 Remote On/Off .....	5
7. Input / Output Considerations .....	5
7.1 Input Capacitance at the Power Module .....	5
7.2 Output Ripple and Noise .....	6
7.3 Output Capacitance .....	6
8. Thermal Design .....	7
8.1 Operating Temperature Range .....	7
8.2 Convection Requirements for Cooling .....	7
8.3 Thermal Considerations .....	7
8.4 Power Derating .....	7
9. Safety & EMC .....	8
9.1 Input Fusing and Safety Considerations .....	8
9.2 EMC Considerations .....	8



# EC4SAWH Series Application Note V10

## 1. Introduction

The EC4SAWH series offer 5-6 watts of output power in a 0.86x0.36x0.44 inches SIP-8 plastic packages. The EC4SAWH series has a 4:1 wide input voltage range of 9-36 and 18-74VDC and provides a precisely regulated output. This series has features such as high efficiency, 3000VDC of isolation and allows an ambient operating temperature range of -40°C to 85°C with de-rating. The features include short circuit protection and Negative remote on/off control. All models are very suitable for distributed power architectures, telecommunications, battery operated equipment and industrial applications.

## 2. Pin Function Description

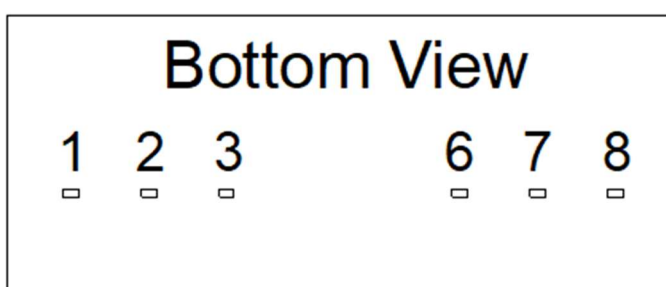

### Single Output

No	Label	Function	Description	Reference
1	●	-V Input	Negative Supply Input	<b>Section 7.1</b>
2		+V Input	Positive Supply Input	<b>Section 7.1</b>
3		Remote On/Off	External Remote On/Off Control	<b>Section 6.2</b>
6		+V Output	Positive Power Output	<b>Section 7.2/7.3</b>
7		-V Output	Negative Power Output	<b>Section 7.2/7.3</b>
8		NC	No Connection with Pin	--

### Dual Output

No	Label	Function	Description	Reference
1	●	-V Input	Negative Supply Input	<b>Section 7.1</b>
2		+V Input	Positive Supply Input	<b>Section 7.1</b>
3		Remote On/Off	External Remote On/Off Control	<b>Section 6.2</b>
6		+V Output	Positive Power Output	<b>Section 7.2/7.3</b>
7		Common	Common Power Output	<b>Section 7.2/7.3</b>
8		-V Output	Negative Power Output	<b>Section 7.2/7.3</b>



# EC4SAWH Series Application Note V10

## 3. Connection for Standard Use

The connection for standard use is shown below. External output capacitors (C1, C2) are recommended to reduce output ripple and noise, 0.1uF ceramic capacitor for all models.

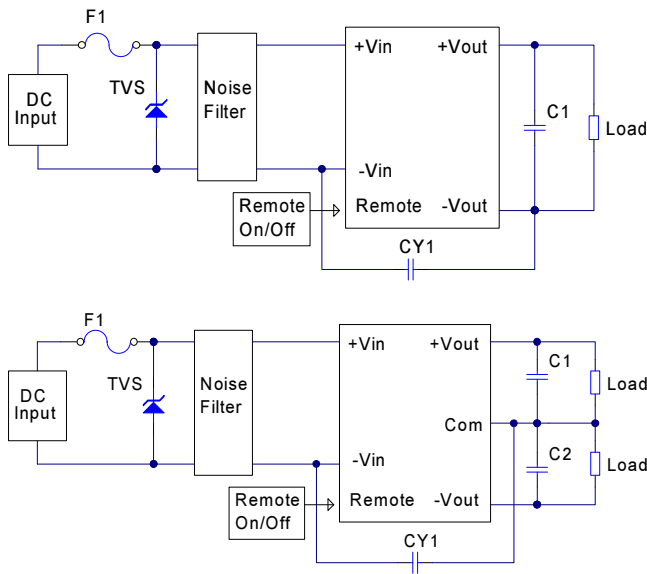

Symbol	Component	Reference
F1, TVS	Input fuse, TVS	Section 9.1
C1, C2, CY1	External capacitor to reduce output ripple and noise	Section 7.2
Noise Filter	External input noise filter	Section 9.2
Remote On/Off	External remote on/off control	Section 6.2

## 4. Test Set-Up

The basic test set-up to measure parameters such as efficiency and load regulation is shown below. When testing the modules under any transient conditions please ensure that the transient response of the source is sufficient to power the equipment under test. We can calculate:

- Efficiency
- Load regulation and line regulation

The value of efficiency is defined as:

$$\eta = \frac{V_o \times I_o}{V_{in} \times I_{in}} \times 100\%$$

Where:

- $V_o$  is output voltage
- $I_o$  is output current
- $V_{in}$  is input voltage
- $I_{in}$  is input current

The value of load regulation is defined as:

$$\text{Load reg.} = \frac{V_{FL} - V_{NL}}{V_{NL}} \times 100\%$$

Where:

- $V_{FL}$  is the output voltage at full load
- $V_{NL}$  is the output voltage at no load

The value of line regulation is defined as:

$$\text{Line reg.} = \frac{V_{HL} - V_{LL}}{V_{LL}} \times 100\%$$

Where:

- $V_{HL}$  is the output voltage of maximum input voltage at full load
- $V_{LL}$  is the output voltage of minimum input voltage at full load

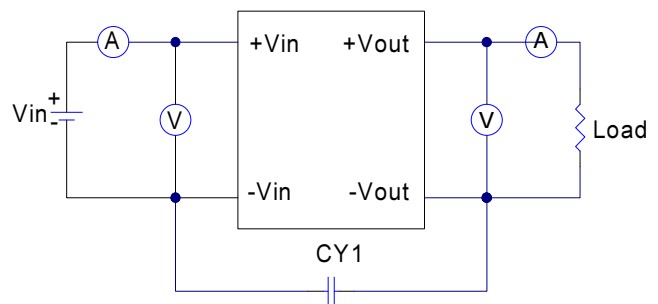

CY1: 1000pF/3KV ceramic capacitor

EC4SAWH Series Test Setup

## 5. Recommend Layout, PCB Footprint and Soldering Information

The system designer or end user must ensure that metal and other components in the vicinity of the converter meet the spacing requirements for which the system is approved. Low resistance and inductance PCB layout traces are the norm and should be used where possible. Due consideration must also be given to proper low impedance tracks between power module, input and output grounds. The recommended footprints and soldering profiles are shown below.

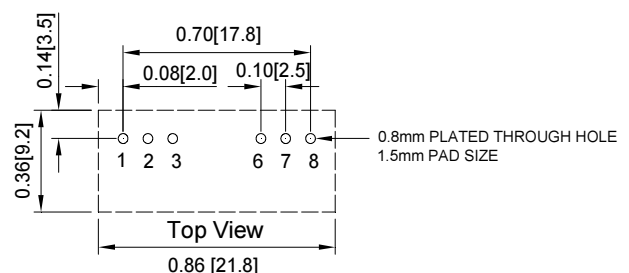

Note: Dimensions are in inches (millimeters)



# EC4SAWH Series Application Note V10

Clean the soldered side of the module with a brush, prevent liquid from getting into the module. Do not clean by soaking the module into liquid. Do not allow solvent to come in contact with product labels or resin case as this may change the color of the resin case or cause deletion of the letters printed on the product label. After cleaning, dry the modules well.

The suggested soldering iron is  $420\pm 10^{\circ}\text{C}$  for up to 4-10 seconds (less than 90W) used in double PCB and multilayer PCB, the other one is  $385\pm 10^{\circ}\text{C}$  for up to 2-6 seconds (less than 90W) used in the single PCB. Furthermore the recommended soldering profile is shown below.

Lead Free Wave Soldering Profile

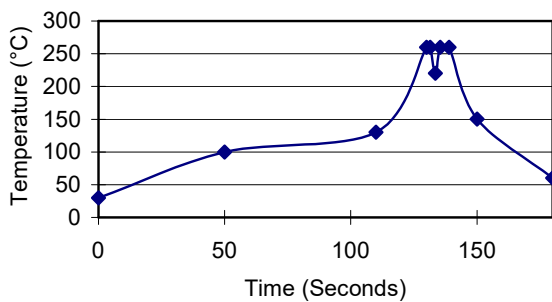

## 6. Features and Functions

### 6.1 Over Current/Short Circuit Protection

All models have internal over current and continuous short circuit protection. The unit operates normally once the fault condition is removed. At the point of current limit inception, the converter will go into hiccup mode protection.

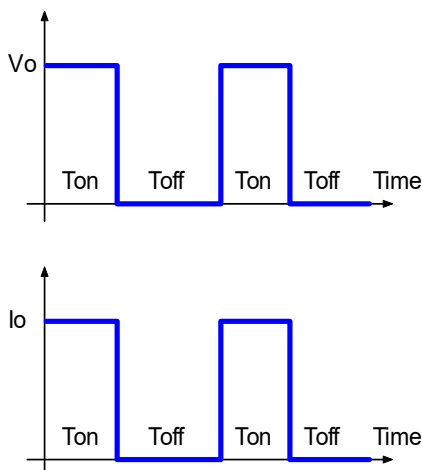

### 6.2 Remote On/Off

The remote on/off input feature of the converter allows external circuitry to turn the converter on or off. Active-high remote on/off is available as standard. The converter is turned on if the remote on/off pin is open circuit. Supplying the on/off pin at 2mA to 4mA will turn the converter off. The signal level of the on/off pin is defined with respect to ground. If not using the on/off pin, leave the pin open (module will be on).

Logic State (Pin 3)	Negative Logic
Logic Low or Open Circuit	Module on
Logic High (current:2~4mA)	Module off

On/Off pin applied current via 1K

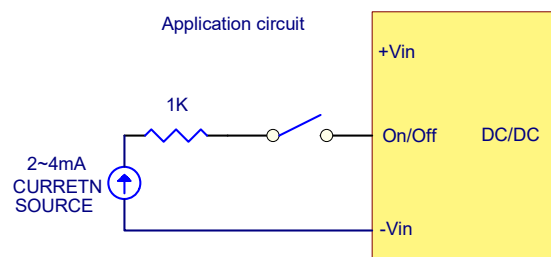

Recommended Application Circuit

## 7. Input / Output Considerations

### 7.1 Input Capacitance at the Power Module

The converters must be connected to low AC source impedance. To avoid problems with loop stability source inductance should be low. Also, the input capacitors ( $C_{in}$ ) should be placed close to the converter input pins to de-couple distribution inductance. However, the external input capacitors are chosen for suitable ripple handling capability. Low ESR capacitors are good choice. Circuit as shown as below represents typical measurement methods for reflected ripple current.  $C_1$  and  $L_1$  simulate a typical DC source impedance. The input reflected-ripple current is measured by current probe to oscilloscope with a simulated source inductance ( $L_1$ ).

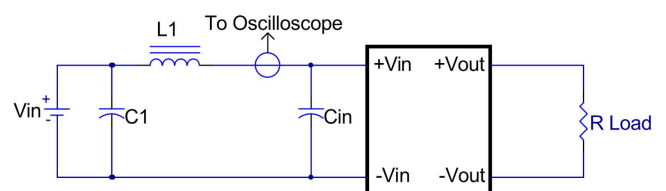

$L_1$ : 12 $\mu\text{H}$   
 $C_1$ : None  
 $C_{in}$ : 47 $\mu\text{F}$  ESR<0.17 $\Omega$  @100KHz



# EC4SAWH Series Application Note V10

## 7.2 Output Ripple and Noise

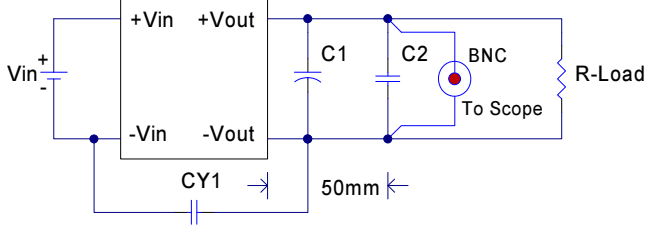

Note: C1: None, C2: None,  
CY1: 1000pF/3KV ceramic capacitor.

EC4SAWH single output module

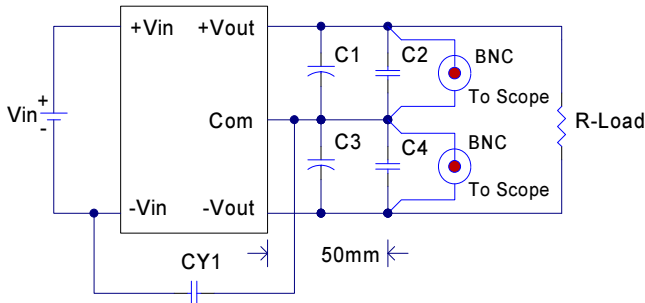

Note: C1 & C3: None, C2 & C4: None,  
CY1: 1000pF/3KV ceramic capacitor.

EC4SAWH dual output module

Output ripple and noise measured with 1000pF ceramic capacitor across input/output, A 20 MHz bandwidth oscilloscope is normally used for the measurement.

The conventional ground clip on an oscilloscope probe should never be used in this kind of measurement. This clip, when placed in a field of radiated high frequency energy, acts as an antenna or inductive pickup loop, creating an extraneous voltage that is not part of the output noise of the converter.



Another method is shown in below, in case of coaxial-cable/BNC is not available. The noise pickup is eliminated by pressing scope probe ground ring directly against the -Vout terminal while the tip contacts the +Vout terminal. This makes the shortest possible connection across the output terminals.

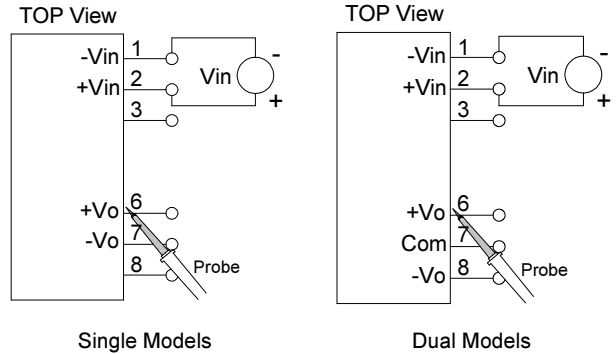

Using Probe to Measure Output Ripple and Noise

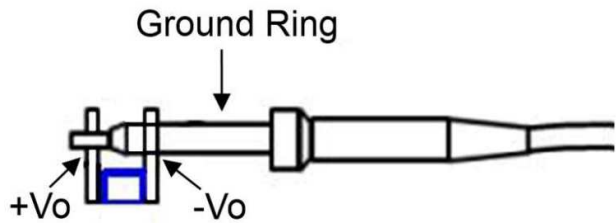

## 7.3 Output Capacitance

The EC4SAWH series converters provide unconditional stability with or without external capacitors. For good transient response, low ESR output capacitors should be located close to the point of load (<100mm). PCB design emphasizes low resistance and inductance tracks in consideration of high current applications. Output capacitors with their associated ESR values have an impact on loop stability and bandwidth. Cincon's converters are designed to work with load capacitance to see technical specifications.



# EC4SAWH Series Application Note V10

---

## 8. Thermal Design

### 8.1 Operating Temperature Range

The EC4SAWH series converters can be operated within a wide case temperature range of  $-40^{\circ}\text{C}$  to  $85^{\circ}\text{C}$ . Consideration must be given to the derating curves when ascertaining maximum power that can be drawn from the converter. The maximum power drawn from models is influenced by usual factors, such as:

- Input voltage range
- Output load current
- Forced air or natural convection

### 8.2 Convection Requirements for Cooling

To predict the approximate cooling needed for the  $0.86''\times 0.36''$  module, refer to the power derating curves in **datasheet**. These derating curves are approximations of the ambient temperatures and airflows required to keep the power module temperature below its maximum rating. Once the module is assembled in the actual system, the module's temperature should be monitored to ensure it does not exceed  $105^{\circ}\text{C}$  as measured at the center of the top of the case (thus verifying proper cooling).

### 8.3 Thermal Considerations

The power module operates in a variety of thermal environments; however, sufficient cooling should be provided to help ensure reliable operation of the unit. Heat is removed by conduction, convection, and radiation to the surrounding environment. The example is presented in **datasheet**. The power output of the module should not be allowed to exceed rated power ( $V_{o\_set} \times I_{o\_max}$ ).

### 8.4 Power Derating

The operating case temperature range of EC4SAWH series is  $-40^{\circ}\text{C}$  to  $+85^{\circ}\text{C}$ . When operating the EC4SAWH series, proper derating or cooling is needed. The maximum case temperature under any operating condition should not exceed  $105^{\circ}\text{C}$  (refer to **datasheet**).



# EC4SAWH Series Application Note V10

## 9. Safety & EMC

### 9.1 Input Fusing and Safety Considerations

The EC4SAWH series converters have no internal fuse. In order to achieve maximum safety and system protection, always use an input line fuse. We recommended a fast acting fuse 1.25A for 24Vin models and 630mA for 48Vin modules. It is recommended that the circuit have a transient voltage suppressor diode (TVS) across the input terminal to protect the unit against surge or spike voltage and input reverse voltage (as shown).

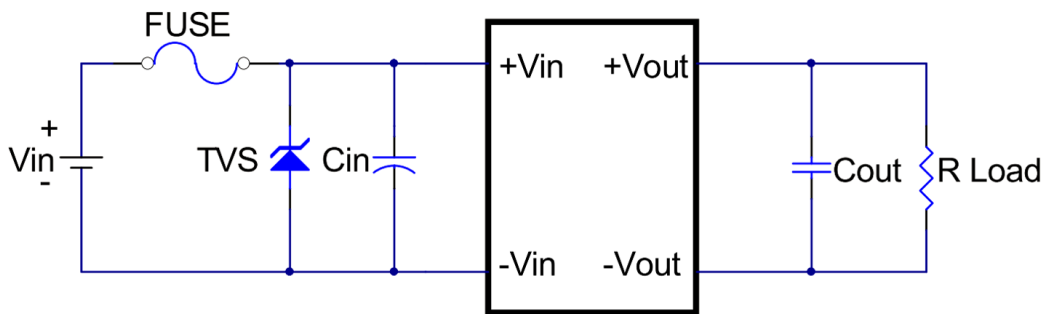

The external TVS & input capacitor (Cin) is required if EC4SAWH series has to meet EN61000-4-4 & EN61000-4-5

### 9.2 EMC Considerations

EMI Test standard: EN55032 Conducted Emission

Test Condition: Input Voltage: Nominal, Output Load: Full Load

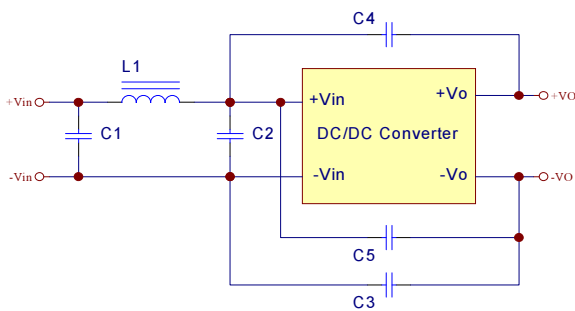

EC4SAWH single output module

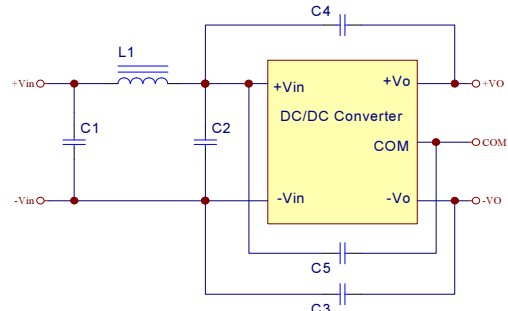

EC4SAWH dual output module

Model Number		C1	C2	C3	C4	C5	L1
Class A	EC4SAW-24xxxHN	10uF/50V	NC	470pF/3KV	470pF/3KV	NC	10uH
	EC4SAW-48xxxHN	2.2uF/100V	NC	470pF/3KV	470pF/3KV	NC	10uH
Class B	EC4SAW-24xxxHN	10uF/50V	NC	1500pF/3KV	1500pF/3KV	NC	15uH
	EC4SAW-48xxxHN	2.2uF/100V x2pcs	2.2uF/100V x2pcs	1500pF/3KV	1000pF/3KV	1500pF/3KV	15uH

Note:

C1, C2: 1210 X7R ceramic capacitor.

C3, C4, C5: 1808 X7R ceramic capacitor.

L1 P/N: NR4018T 100M, TAIYO for Class A or SR0403150MLB, ABC for Class B





# EC4SAWH Series Application Note V10

## Conducted Emission Class A:

EC4SAW-24S33HN

Line

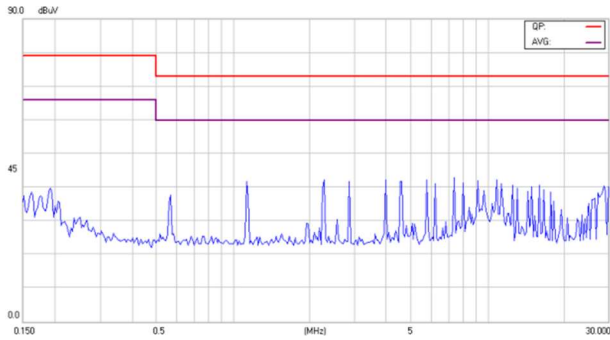

Neutral

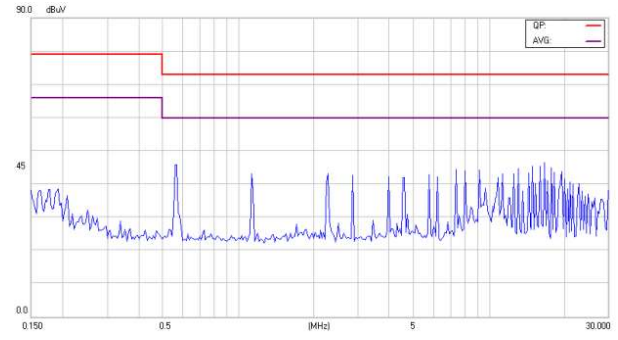

EC4SAW-24S05HN

Line

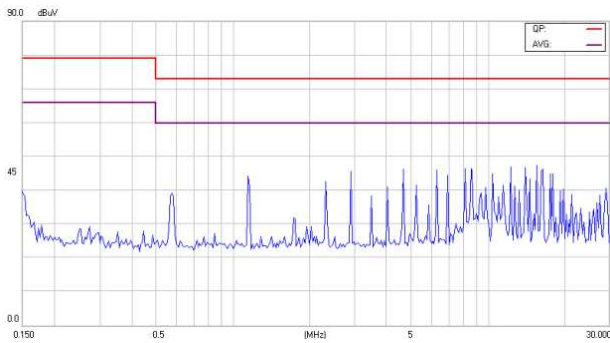

Neutral

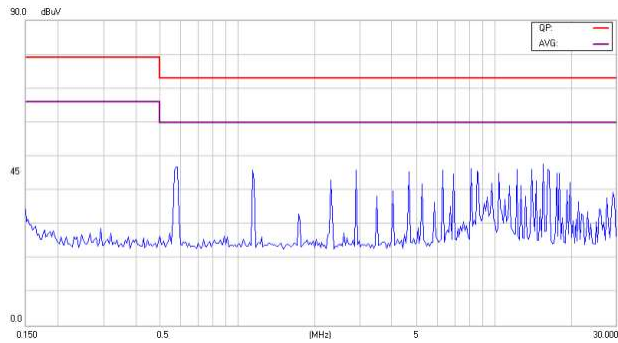

EC4SAW-24S12HN

Line

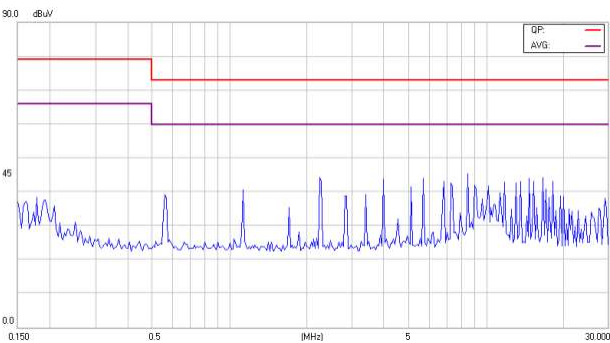

Neutral

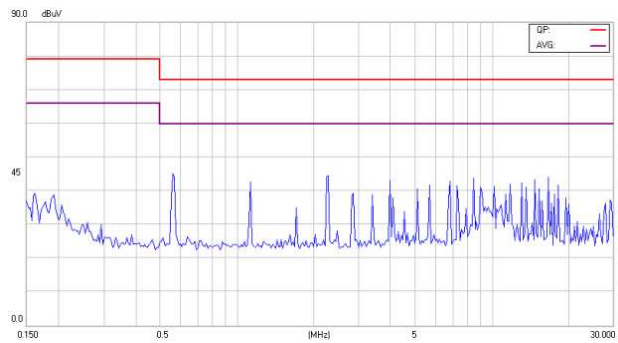

EC4SAW-24S15HN

Line

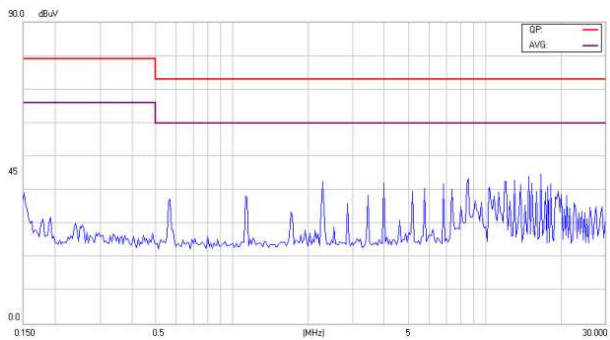

Neutral

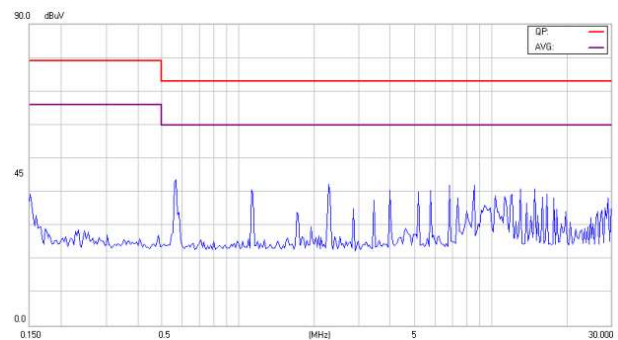



# EC4SAWH Series Application Note V10

## EC4SAW-24D05HN

Line

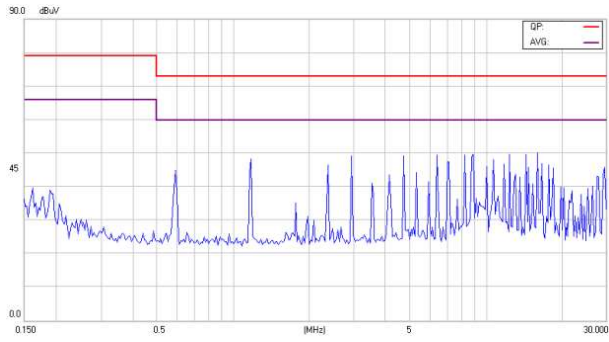

Neutral

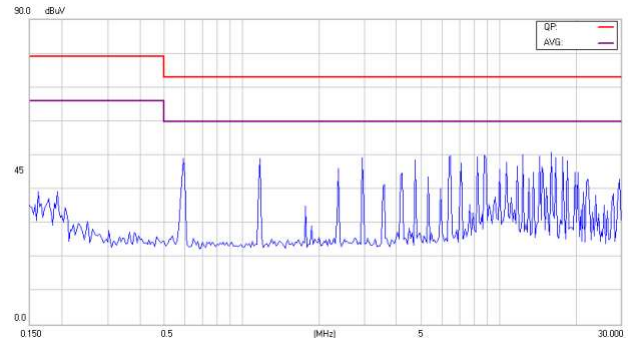

## EC4SAW-24D12HN

Line

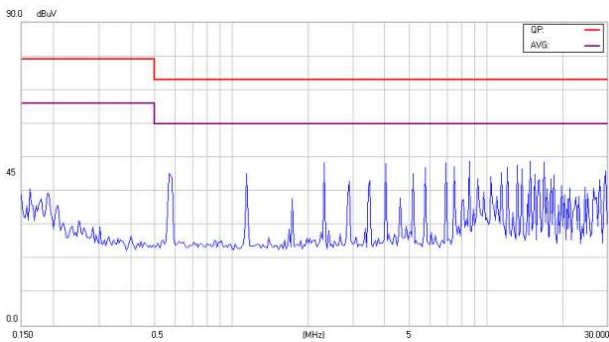

Neutral

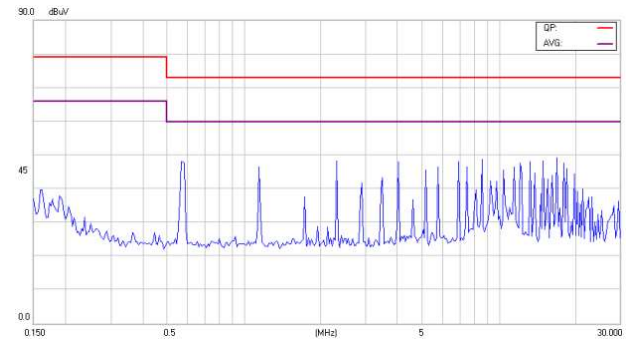

## EC4SAW-24D15HN

Line

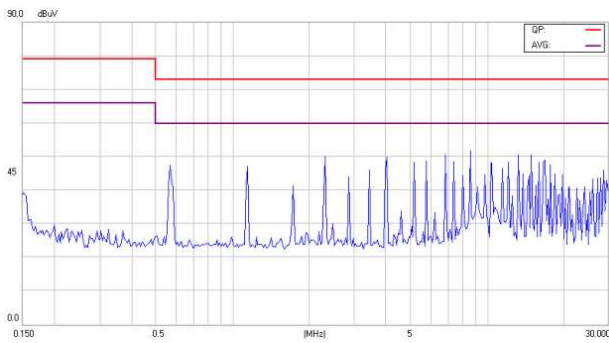

Neutral

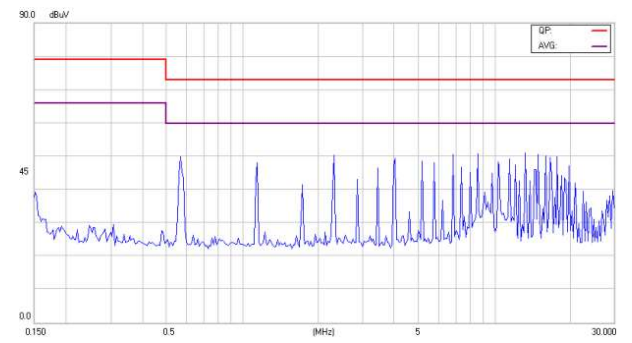

## EC4SAW-48S33HN

Line

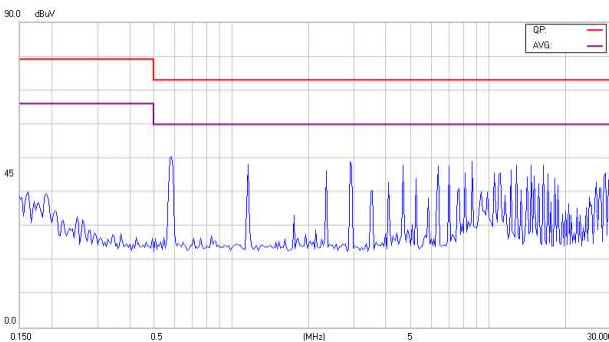

Neutral

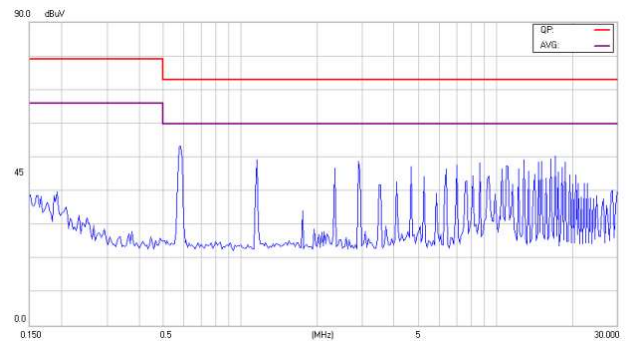



# EC4SAWH Series Application Note V10

EC4SAW-48S05HN

Line

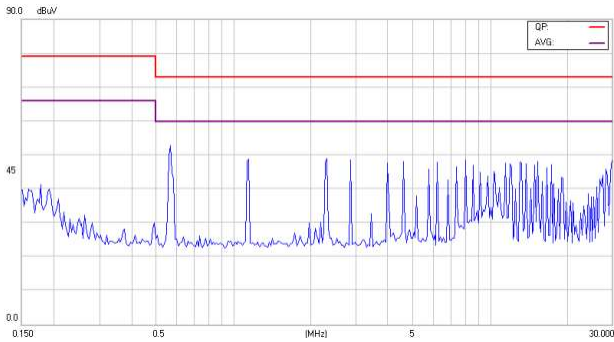

Neutral

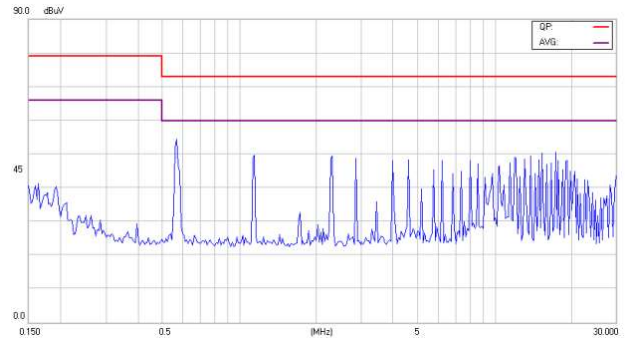

EC4SAW-48S12HN

Line

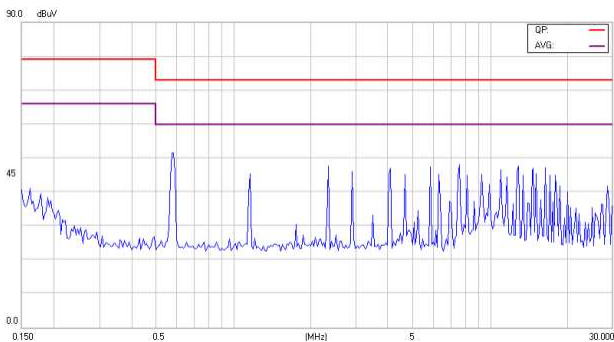

Neutral

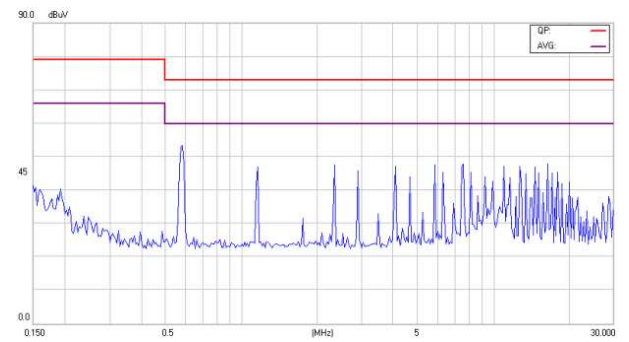

EC4SAW-48S15HN

Line

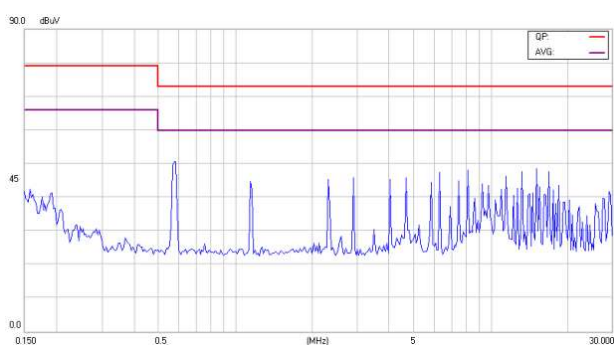

Neutral

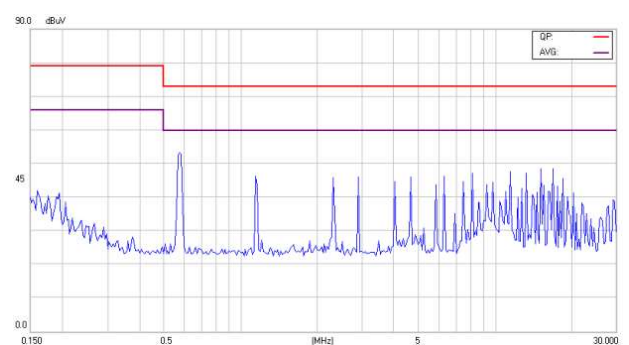

EC4SAW-48D05HN

Line

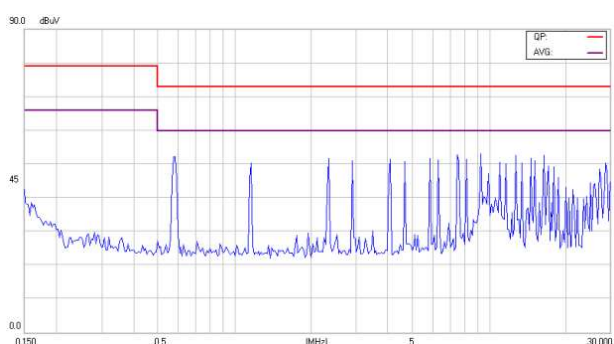

Neutral

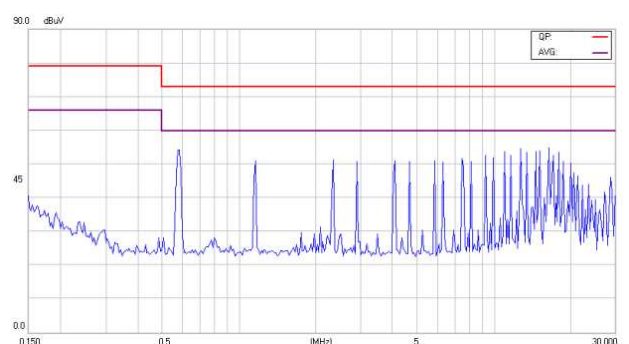



# EC4SAWH Series Application Note V10

## EC4SAW-48D12HN

Line

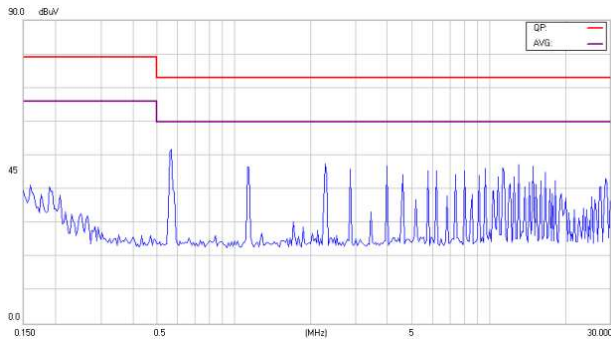

Neutral

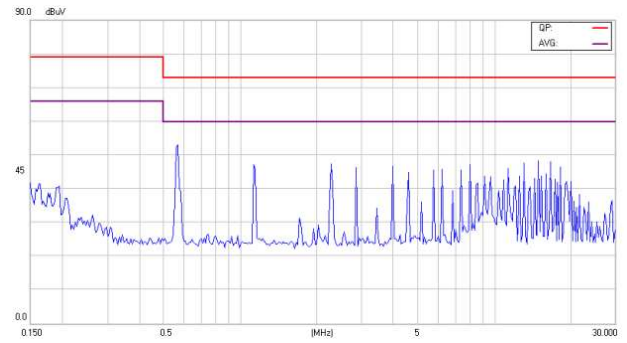

## EC4SAW-48D15HN

Line

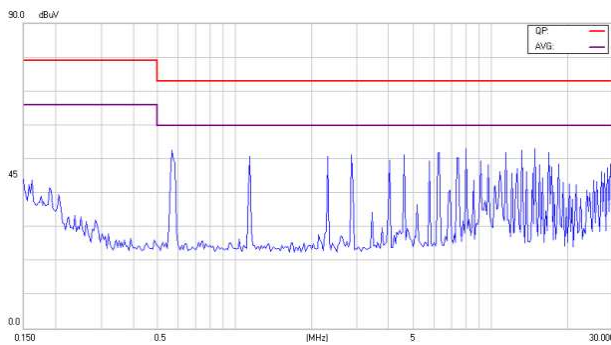

Neutral

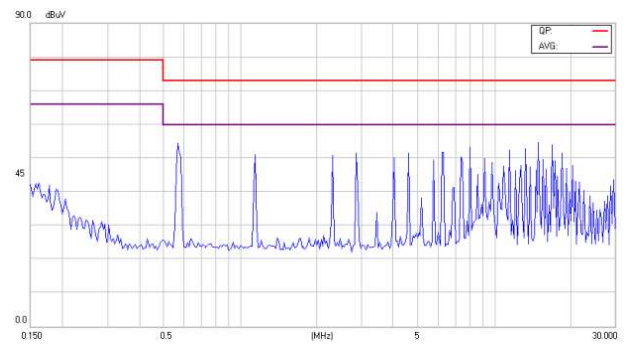

## Conducted Emission Class B:

### EC4SAW-24S33HN

Line

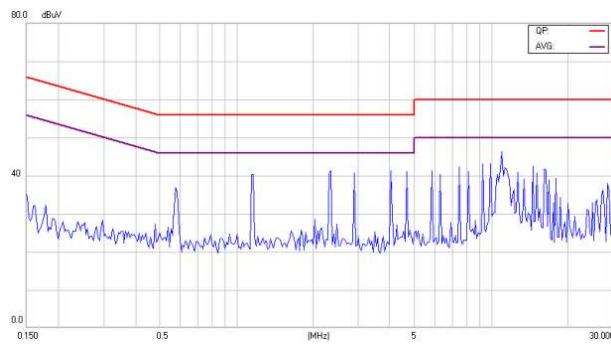

Neutral

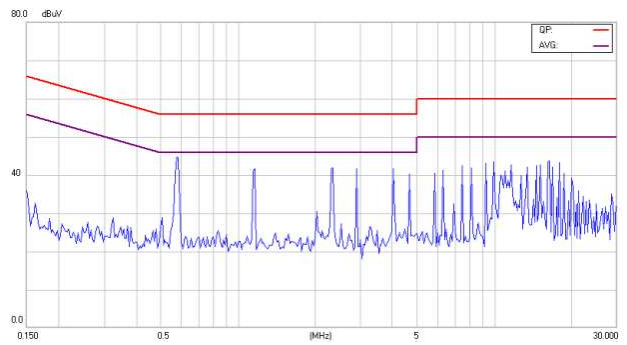





# EC4SAWH Series Application Note V10

EC4SAW-24S05HN

Line

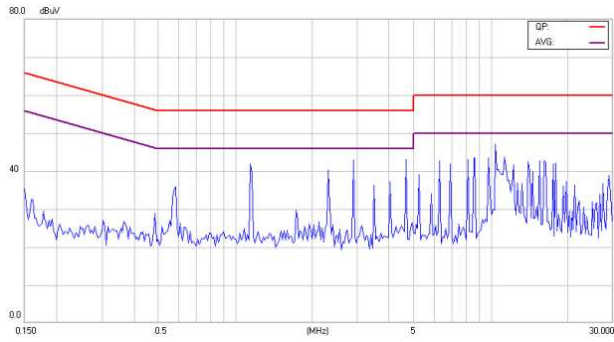

Neutral

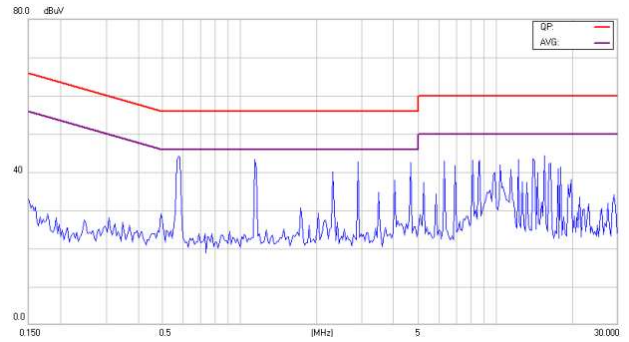

EC4SAW-24S12HN

Line



Neutral

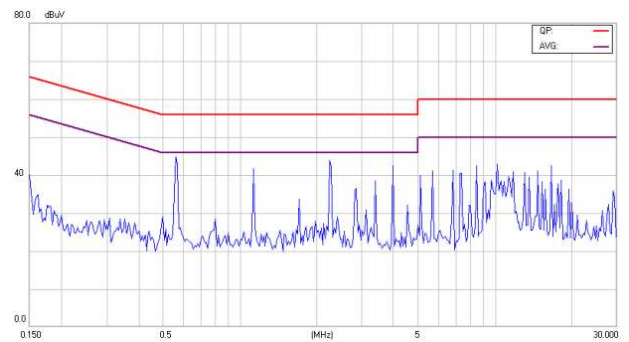

EC4SAW-24S15HN

Line

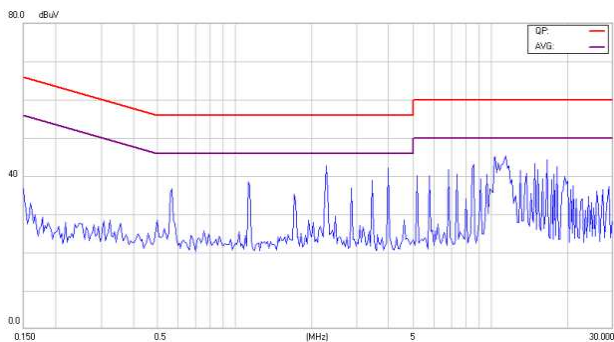

Neutral

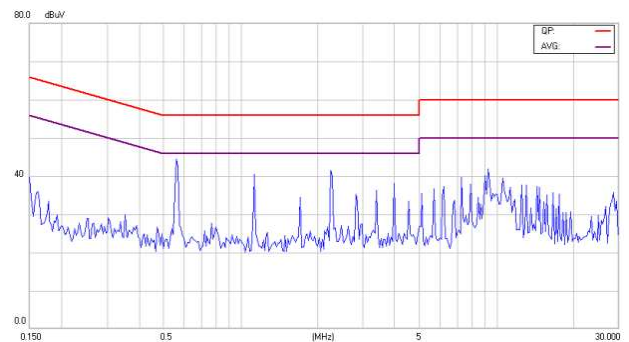

EC4SAW-24D05HN

Line

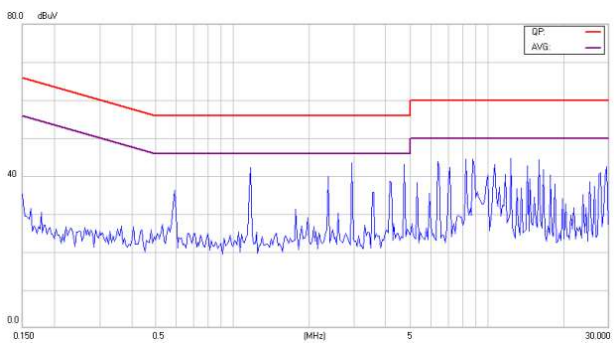

Neutral

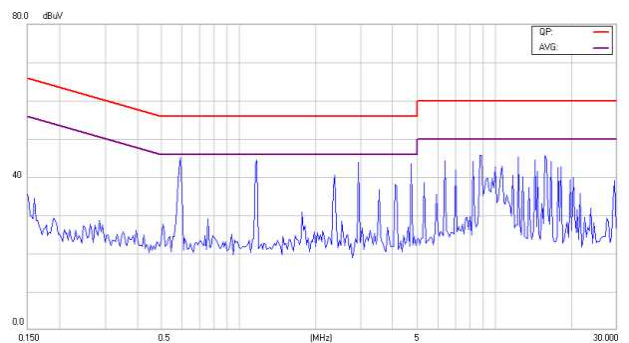



# EC4SAWH Series Application Note V10

EC4SAW-24D12HN

Line

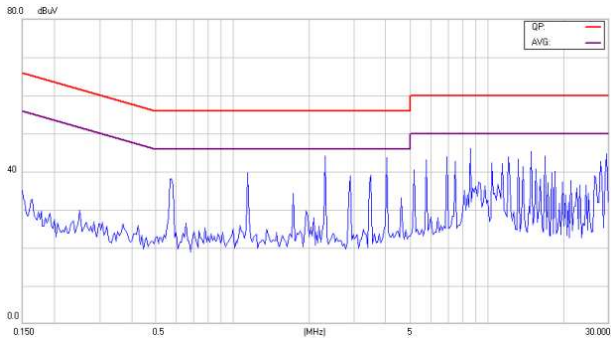

Neutral

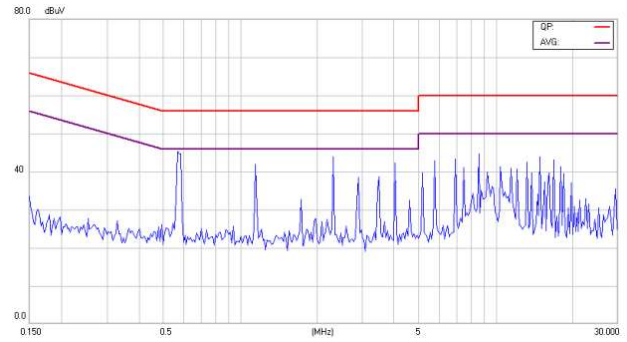

EC4SAW-24D15HN

Line

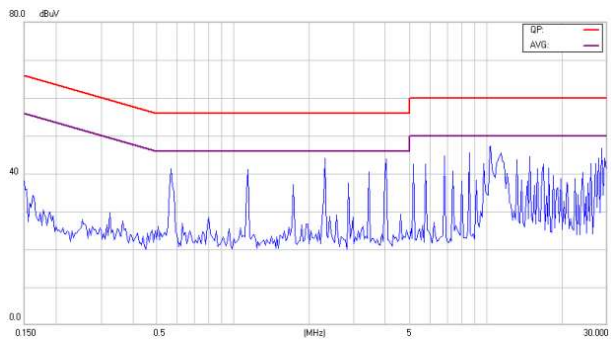

Neutral

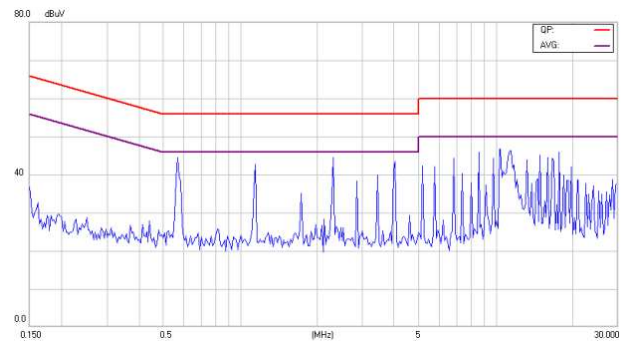

EC4SAW-48S33HN

Line

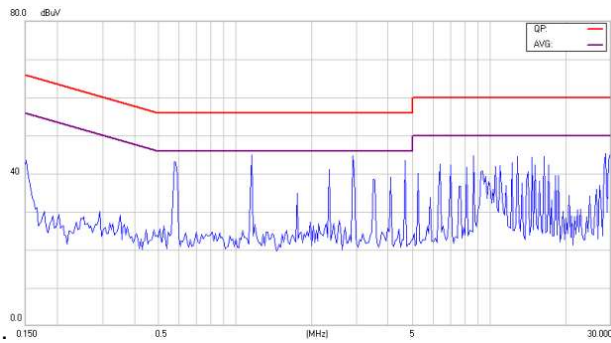

Neutral

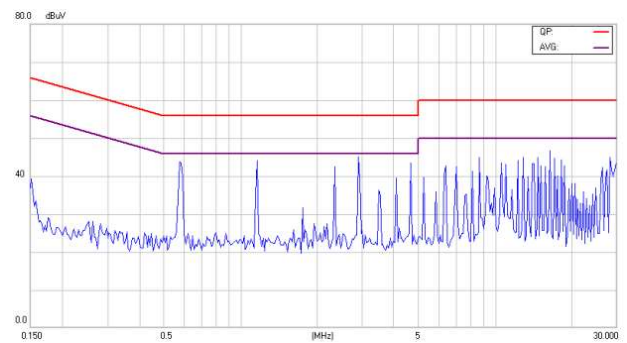

EC4SAW-48S05HN

Line

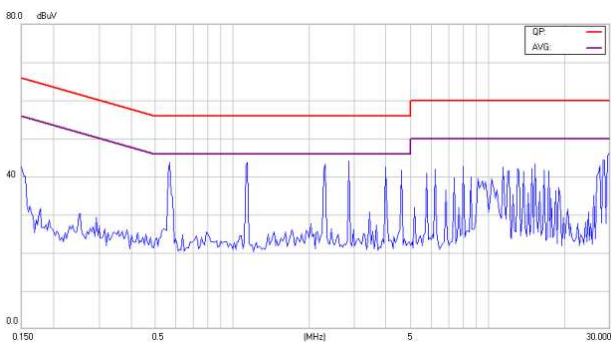

Neutral

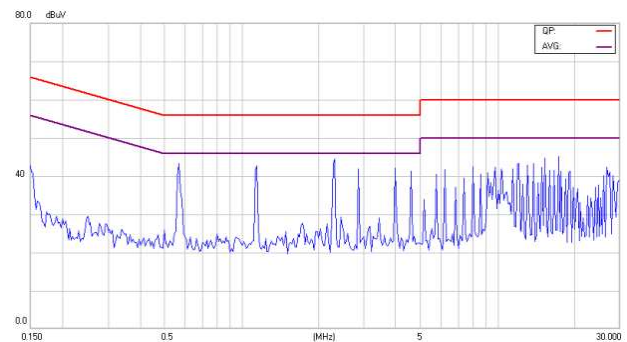



# EC4SAWH Series Application Note V10

## EC4SAW-48S12HN

Line

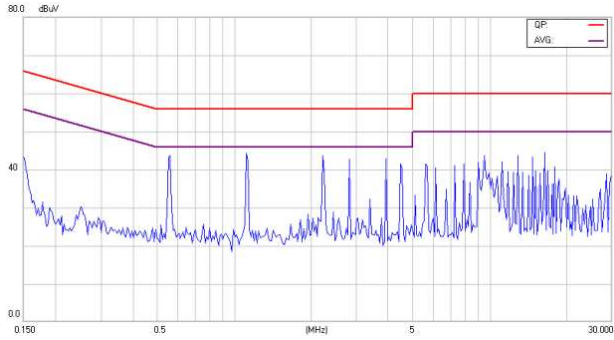

Neutral

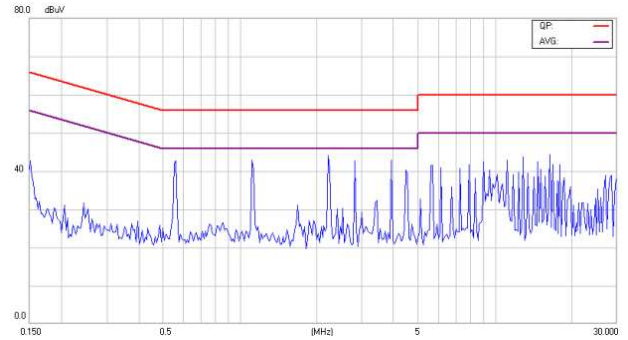

## EC4SAW-48S15HN

Line

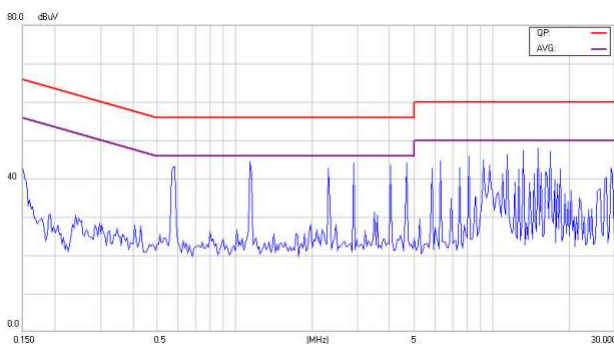

Neutral

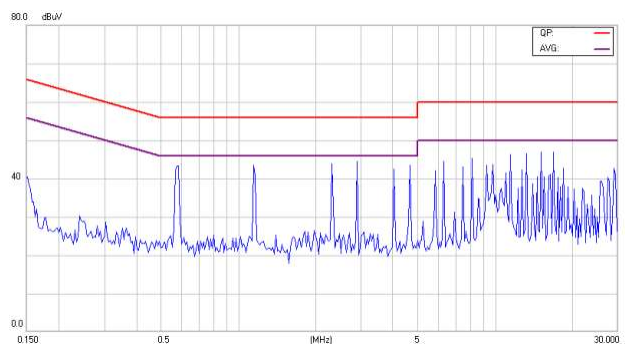

## EC4SAW-48D05HN

Line

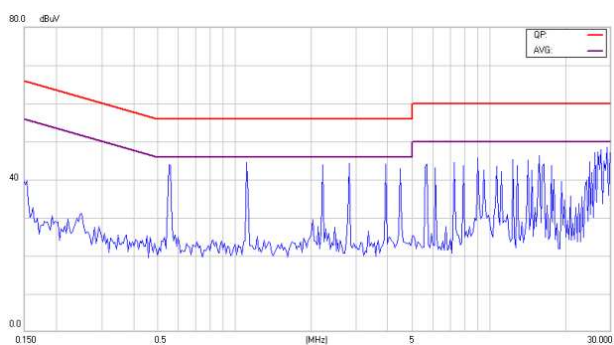

Neutral

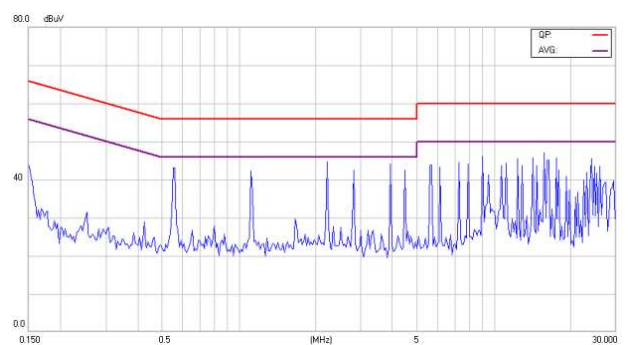

## EC4SAW-48D12HN

Line

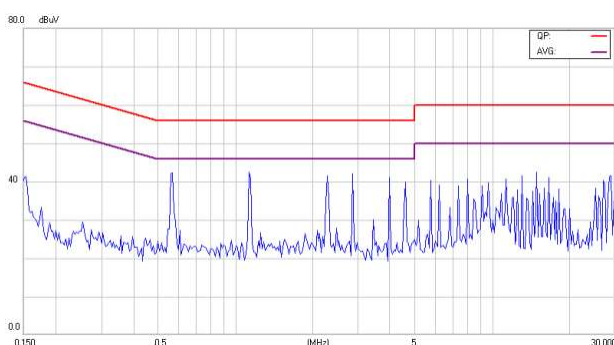

Neutral

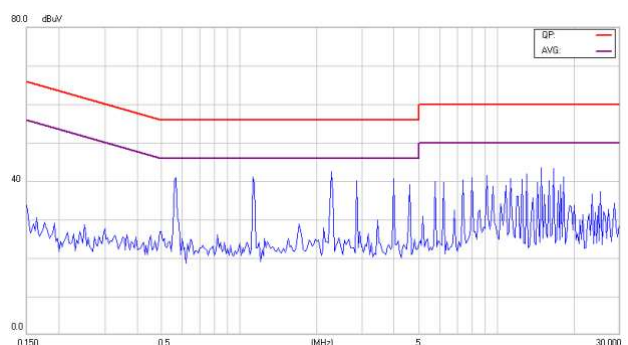



# EC4SAWH Series Application Note V10

EC4SAW-48D15HN

Line

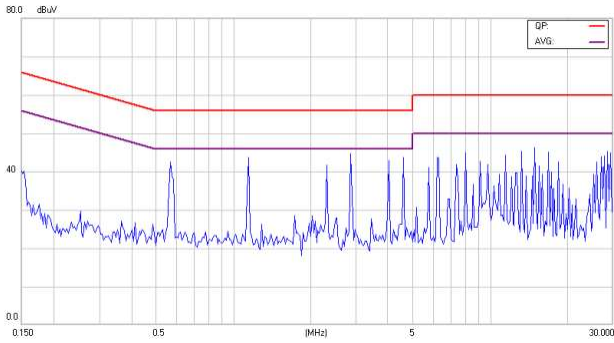

Neutral

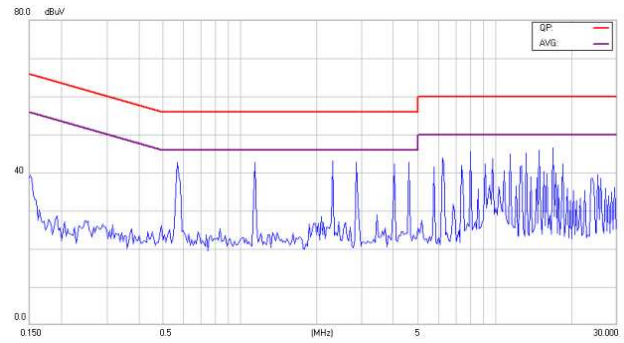

## Headquarters:

14F, No.306, Sec.4, Hsin Yi Rd.  
Taipei, Taiwan  
Tel: 886-2-27086210  
Fax: 886-2-27029852  
E-mail: [support@cincon.com.tw](mailto:support@cincon.com.tw)  
Web: [www.cincon.com](http://www.cincon.com)

## CINCON ELECTRONICS CO., LTD.

### Factory:

No. 8-1, Fu Kung Rd.  
Fu Hsing Industrial Park  
Fu Hsing Hsiang,  
ChangHua Hsien, Taiwan  
Tel: 886-4-7690261  
Fax: 886-4-7698031

### Cincon North America:

1655Mesa Verde Ave. Ste 180  
Ventura, CA93003  
Tel: 805-639-3350  
Fax: 805-639-4101  
E-mail: [info@cincon.com](mailto:info@cincon.com)