

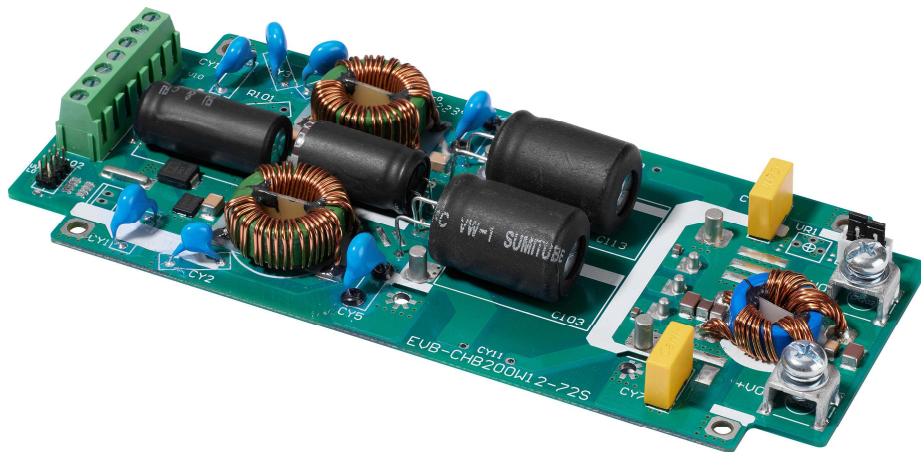

EVB-CHB200W12-72S Series Application Note V10

Evaluation Board for CHB200W12-72S Series APPLICATION NOTE



Approved By:

Department	Approved By	Checked By	Written By
Research and Development Department	Jacky	Astray	Jiawei
Design Quality Department	Benny	JoJo	



EVB-CHB200W12-72S Series Application Note V10

Contents

1. Introduction	3
2. Pin Function Description Input and Output Connections.....	4
3. Output Remote Sense, Trim Resistors.....	5
3.1 Output Remote Sensing	5
3.2 Output Voltage Adjustment.....	5
3.3 UVLO (Under Voltage Lock Out).....	5
4. Schematic	6
5. Component Placement.....	6
6. Bill of Materials (BOM)	8



EVB-CHB200W12-72S Series

Application Note V10

1. Introduction

The EVB-CHB200W12-72S is the evaluation board for testing CHB200W12-72S series. It has a (12:1) input voltage range of 14 to 160VDC. For help in testing the performance of DC-DC converters, please refer to the [CHB200W12-72S application note](#).

Shock Warning:

Certain areas of the evaluation board are exposed to high voltage. Be careful to avoid contact with these voltages. After disconnecting the input power, the evaluation board may temporarily maintain high voltage. Be careful when handling.

Application of Input Power:

The evaluation board **prohibits hot plugging**. So **don't use** a knife switch or circuit breaker to connect the input power. This type of action applies the input voltage at an uncontrolled very high rate of rise (dV/dt), which may damage the converter and external components before the converter. The input voltage should be applied at a controlled rate of rise (recommend 10V/ μ S). Also, before inserting or removing the converter module from the evaluation board, make sure that the input voltage is turned off.

Thermal Considerations:

When testing the converter on the evaluation board, ensure adequate cooling. Use a fan to blow the cooling air so that the fan blows through the converter or the radiator connected to the converter. The converter temperature to ensure that it does not exceed the maximum rated temperature specified in the data sheet.

Sockets of DC DC Converter:

The evaluation board uses sockets to provide options for testing different converters. These sockets are not suitable for continuous high current. Short-term testing is possible, but please be aware of this limitation of long-term testing. The socket will add resistance in the power loop, which will cause a voltage drop at higher currents, which can cause significant errors in regulation and efficiency measurements. These socket also do not provide a thermal cooling path from the module pins to the PCB wiring, which may cause higher converter temperatures and errors when performing thermal evaluation. For long-term testing, thermal testing and permanent installation, it is recommended to use soldered connections.



EVB-CHB200W12-72S Series Application Note V10

2. Pin Function Description Input and Output Connections

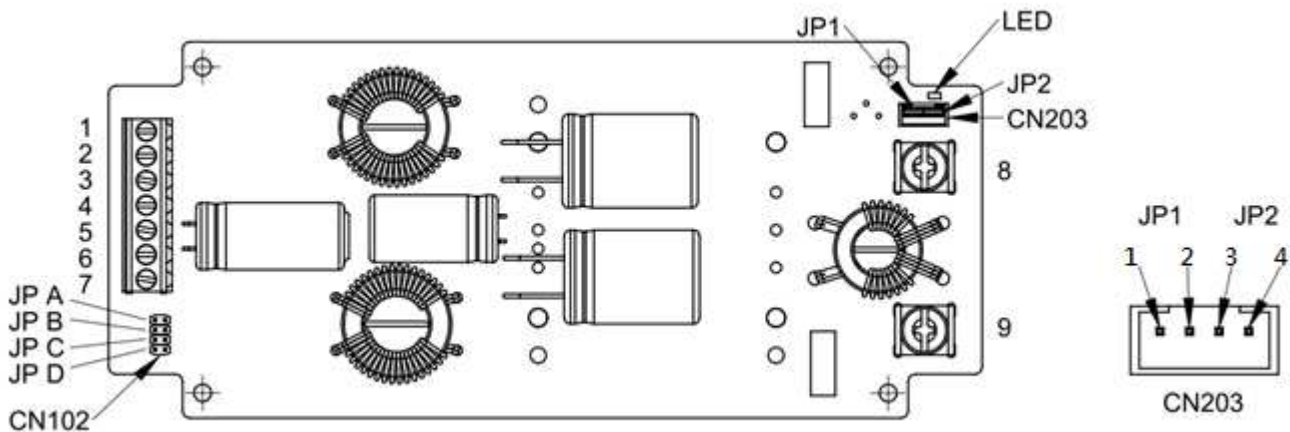

No	PIN FUNCTION	Description
1	CASE	Connected to DC Module Case
2	On/Off	External Remote On/Off Control
3	Bus	Pre-Regulator Voltage Output
4	-V Input	Negative Supply Input
5	-V Input	Negative Supply Input
6	+V Input	Positive Supply Input
7	+V Input	Positive Supply Input
8	-V Output	Negative Power Output
9	+V Output	Positive Power Output

No	CN102	Description
JP A	UVLO SET UP	UVLO Threshold Adjust (VIN=36V)
JP B	UVLO SET UP	UVLO Threshold Adjust (VIN=48V)
JP C	UVLO SET UP	UVLO Threshold Adjust (VIN=72V)
JP D	UVLO SET UP	UVLO Threshold Adjust (VIN=110V)

No	CN203	Description
1	+V Output	Positive Power Output
2	+Sense	Positive Output Remote Sense
3	-Sense	Negative Output Remote Sense
4	-V Output	Negative Power Output

Note: DC module Case can be connected to PCB through M3 threaded mounting insert. Recommended torque 3Kgf-cm.



EVB-CHB200W12-72S Series Application Note V10

3. Output Remote Sense, Trim Resistors

3.1 Output Remote Sensing

The CHB200W12-72S series converter has the capability to remotely sense both lines of its output. This feature moves the effective output voltage regulation point from the output of the unit to the point of connection of the remote sense pins. This feature automatically adjusts the real output voltage of the CHB200W12-72S series in order to compensate for voltage drops in distribution and maintain a regulated voltage at the point of load. The remote-sense voltage range please refer to the [CHB200W12-72S application note](#).

When remote sensing is used, please remove the jumper of CN203 and the sense should be connected by twisted-pair wire or shield wire. If the sensing patterns short, heavy current flows and the pattern may be damaged. Output voltage might become unstable because of impedance of wiring and load condition when length of wire is exceeding 400mm. This is shown in the schematic below.

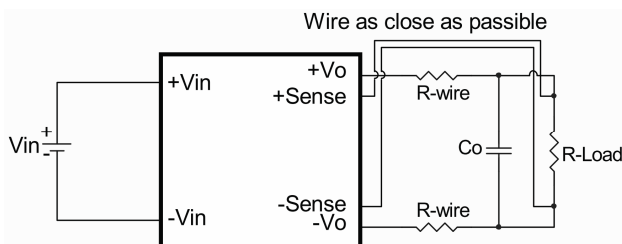

When the EVB-CHB200W12-72S was shipped from a factory, they come with JP1 and JP2 placed on CN203. If the remote sense feature is not to be used, the sense JP1 and JP2 should be connected locally.

Note:

Although the output voltage can be varied (increased or decreased) by both remote sense and trim, the maximum variation for the output voltage is the larger of the two values not the sum of the values. The output power delivered by the module is defined as the voltage at the output terminals multiplied by the output current. Using remote sense and trim can cause the output voltage to increase and consequently increase the power output of the module if output current remains unchanged. Always ensure that the output power of the module remains at or below the maximum rated power. Also be aware that if $V_{o,set}$ is below nominal value, $P_{out,max}$ will also decrease accordingly because $I_{o,max}$ is an absolute limit. Thus, $P_{out,max} = V_{o,set} \times I_{o,max}$ is also an absolute limit.

3.2 Output Voltage Adjustment

EVB- CHB200W12-72S is shipped without trim resistor for output voltage adjustment, output voltage can be adjusted by external variable resistor (adjustment range: please refer to the [CHB200W12-72S application note](#)).

Note:

Description of Trim Resistors

Fixed resistor R201 are used to adjust down the output voltage set-point of the converter.

Fixed resistor R202 are used to adjust up the output voltage set-point of the converter.

The trim resistors R201, R202, and VR are not populated in this evaluation board. This is to allow the user to determine and install the needed trim resistance values based on the range of desired output voltage adjustment of the module being evaluated.

3.3 UVLO (Under Voltage Lock Out)

Input under voltage lockout is standard on the CHB200W12-72S series unit. The unit will shut down when the input voltage drops below a lower threshold, and the unit will operate when the input voltage goes above the upper threshold.

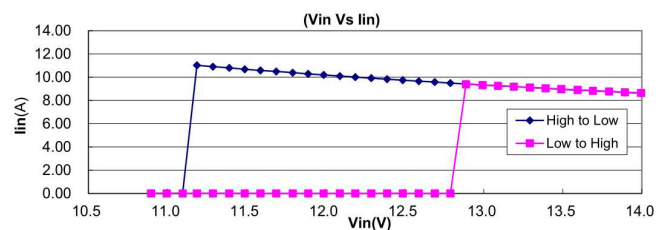

And the CHB200W12-72S series has an(CN102) adjustable under voltage lockout which will shut down the converter according to following settings.

Nom. Input Voltage (VDC)	24	36	48	72	110
Turn Off Threshold (VDC)	11.0±0.5	20.0±1.0	27.3±1.0	41.6±1.0	53.0±1.0
Turn On Threshold (VDC)	13.0±0.5	22.0±1.0	29.6±1.0	44.6±1.0	58.0±1.0
CN102 Setting					
JP A	Open	Short	Open	Open	Open
JP B	Open	Open	Short	Open	Open
JP C	Open	Open	Open	Short	Open
JP D	Open	Open	Open	Open	Short



EVB-CHB200W12-72S Series Application Note V10

4. Schematic

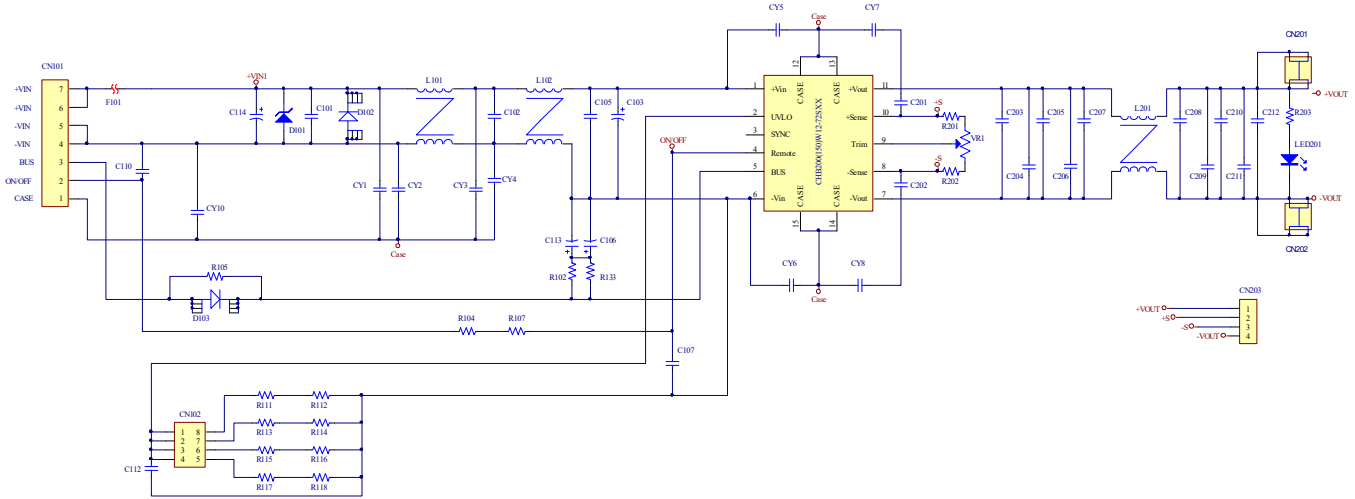

Figure1 Schematic

5. Component Placement

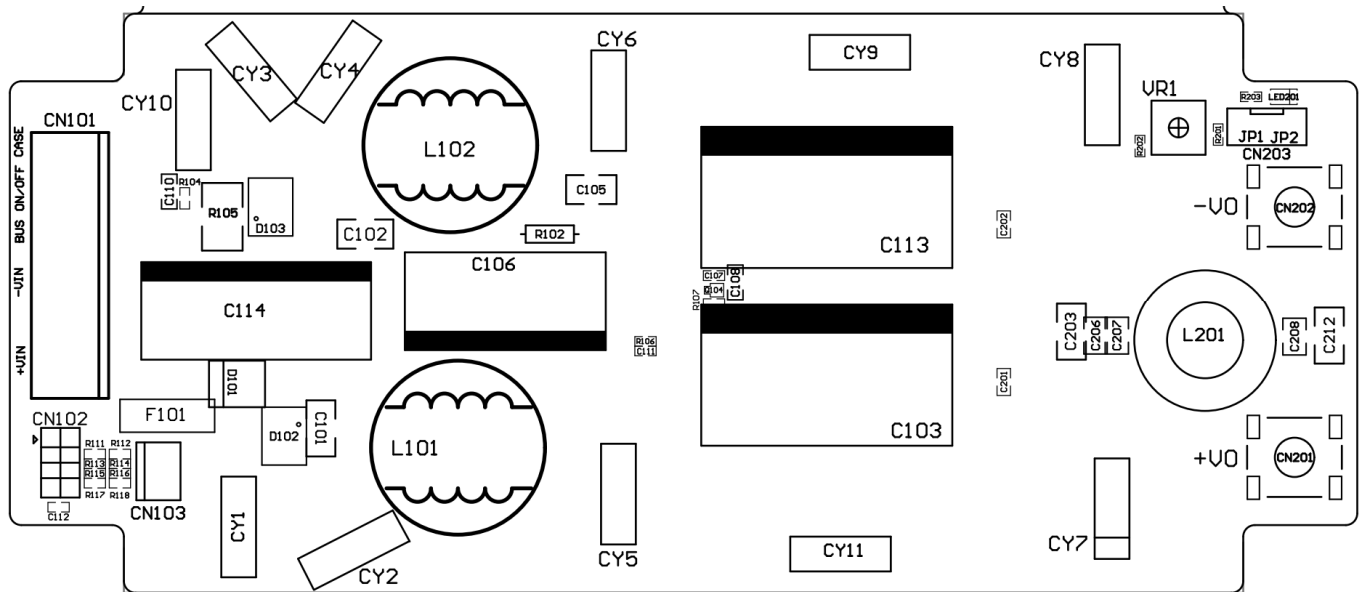

Figure2 TOP Component Placement



EVB-CHB200W12-72S Series Application Note V10

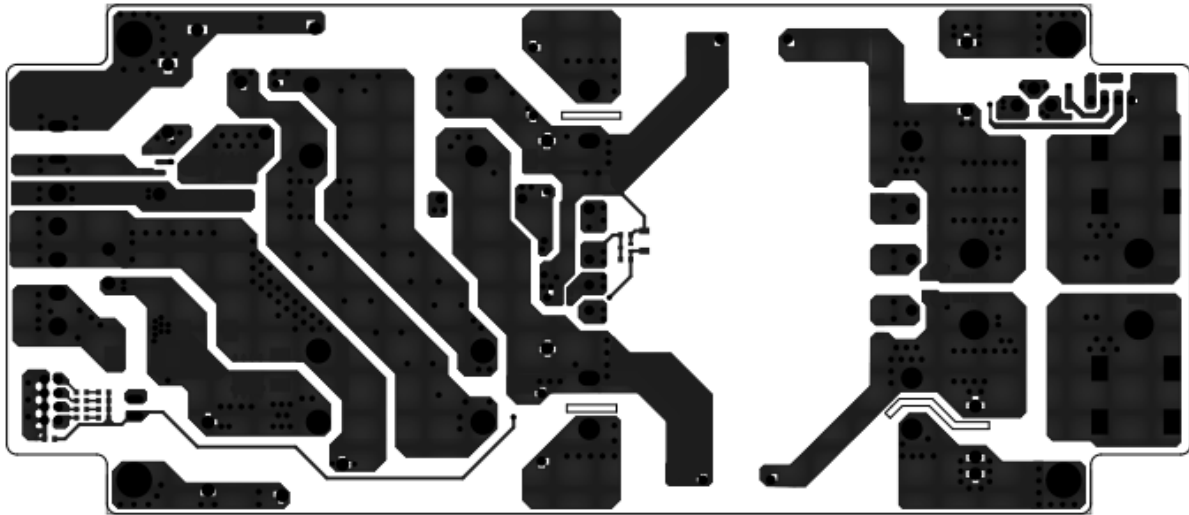

Figure3 PCB Layout Top View

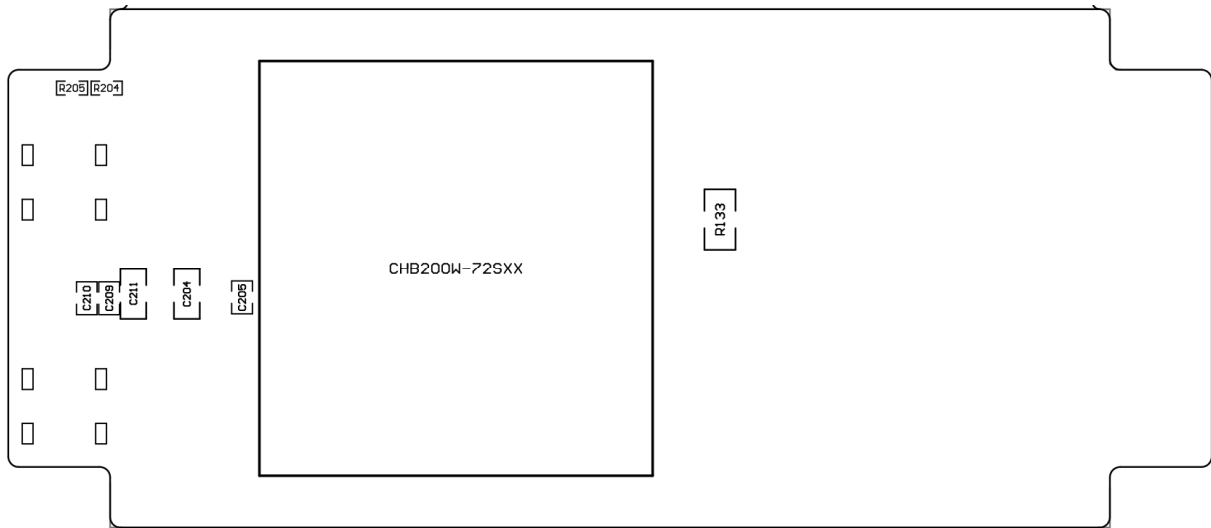

Figure4 Bottom, Component Placement

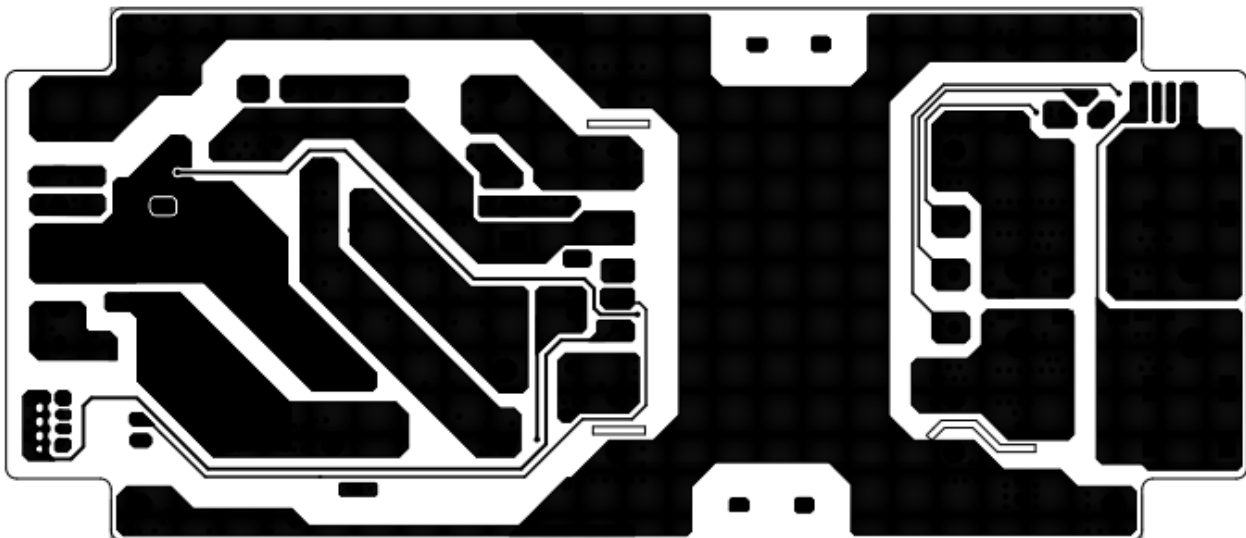

Figure5 PCB Layout Bottom View



EVB-CHB200W12-72S Series Application Note V10

6. Bill of Materials (BOM)

Components value:

Designator	Description	Value	Comment
C103, C113	ALUMINUM CAP.	220uF/200V	EKXJ201ELL221MM25S or equivalent
C106	ALUMINUM CAP.	82uF/250V	EKXJ251ELL820MK25S or equivalent
C114	ALUMINUM CAP.	120uF/220V	EKXJ221ELL121MK30S or equivalent
CY1, CY10	Y1 CAP.	470pF/400VAC	CD85-B2GA471KYNKA or equivalent
CY2	Y1 CAP.	330pF/400VAC	CD75-B2GA331KYNKA or equivalent
CY3, CY4, CY5, CY6	Y2 CAP.	2200pF/400VAC	CD90ZU2GA222MYNKA or equivalent
CY7, CY8	X2 CAP.	0.022uF/275V	PX223K3IC29L200D9R or equivalent
Using in CY5, CY6	BEAD CORE	A6B T 4*1.5*2	KING CORE or equivalent
L101, L102,	Common choke DIP	0.7mH	CMK-05 CINCON (G93A0508100102)
L201	Common choke DIP	0.12mH	CMK-07 CINCON (G93A0307020302)
JP1, JP2 Using in CN203	MINI JUMPER	2.0mm	HMJ20-02O-95BS or equivalent
CN101	TERMINAL BLOCK	300V, 20A	EK500V-07P DINKLE or equivalent
CN203	WAFER	2.0mm Pitch	P110I-04 or equivalent
CN201, CN202	TERMINAL BLOCK	85A	P-831N DINKLE or equivalent
R104, R107, R112, R114 R116, R118	CHIP RESISTOR	1/10W 0R	SMD 0603
R105	METAL STRIP RESISTOR	2W 3mR	SMD 2512
R111	CHIP RESISTOR	1/10W 62K	SMD 0603
R113	CHIP RESISTOR	1/10W 34K	SMD 0603
R115	CHIP RESISTOR	1/10W 18K	SMD 0603
R117	CHIP RESISTOR	1/16W 10K	SMD 0603
R133	Conductive copper strip	6*3.9*1.5mm	Short
R203	CHIP RESISTOR	1/10W 68K	SMD 0603
C102, C105, C101,	CHIP CAP.	1uF/250V X7R	SMD 1812
C107, C112	CHIP CAP.	0.1uF/100V X7R	SMD 0603
C110	CHIP CAP.	0.1uF/250V X7R	SMD 1206
C201, C202,	CHIP CAP.	0.1uF/100V X7R	SMD 0805
C203, C212, C204, C211	CHIP CAP.	2.2uF/100V X7R	SMD 1812
C208,	CHIP CAP.	0.1uF/630V X7R	SMD 1210
C209, C210,	CHIP CAP.	1uF/100V X7R	SMD 1210
C206, C207, C205	CHIP CAP.	2.2uF/100V X7R	SMD 1210
D102, D103,	ULTRAFAST DIODE	300V 8A	STTH8R03DJF-TR or equivalent
D101,	TVS DIODE	1500W 211.5V	SMCJ180A or equivalent
LED201	LED	Green	MS-PT3216ZGSC or equivalent
F101	Conductive copper strip	1.5*2*10mm	Short
P1, P6, P7, P11	SOCKET	2mm	1726TLG or equivalent
P2, P3, P4, P5, P8, P9, P10	SOCKET	1mm	3819TLG or equivalent

CINCON ELECTRONICS CO., LTD.

Headquarters:

14F, No.306, Sec.4, Hsin Yi Rd.
Taipei, Taiwan
Tel: 886-2-27086210
Fax: 886-2-27029852
E-mail: sales@cincon.com.tw
Web Site: <https://www.cincon.com>

Factory:

No. 8-1, Fu Kung Rd.
Fu Hsing Industrial Park
Fu Hsing Hsiang,
ChangHua Hsien, Taiwan
Tel: 886-4-7690261
Fax: 886-4-7698031

Cincon North America:

1655Mesa Verde Ave. Ste 180
Ventura, CA93003
Tel: 805-639-3350
Fax: 805-639-4101
E-mail: info@cincon.com